



Guide for emergency and recovery personnel

Information on rescue from vehicles of the Volkswagen and Volkswagen Commercial Vehicles brands that have been involved in accidents

Version dated: January 2024



Legal notice:

This guide was created exclusively for emergency and recovery personnel who are specially trained in technical assistance after road accidents and can therefore carry out the activities described in it.

Furthermore, the guide contains information about vehicles intended for sale in the European Union.

It does not contain any information about vehicles intended for sale outside the European Union.

Specifications and special equipment in Volkswagen vehicles, and the range of vehicles made by Volkswagen AG, are subject to constant changes.

Volkswagen therefore explicitly reserves the right to modify or change the content of this guide at any time.

The information was up to date at the time it was written.

Please note:

The information contained in this guide is not intended for end customers, and also not for qualified workshops and dealerships.

End customers can find information on the functions of their Volkswagen AG vehicle, as well as important vehicle and passenger safety information, in the vehicle wallet. Workshops and dealerships receive repair information from their accustomed sources.

© Volkswagen AG

Contents

List of abbreviations.....	6	Exterior features of the vehicle	20
Preface.....	8	Volkswagen Commercial Vehicles with camping gas equipment.....	21
0. Scope of guideline for rescue services.....	9	Current Volkswagen Commercial Vehicles with	
Area of application	11	camping gas equipment	21
Identification of drive types	11	Distinguishing features of camping gas vehicles	22
Volkswagen range of models	11	Exterior features of the vehicle	22
Volkswagen Commercial Vehicles model range.....	12	Features in the vehicle interior	22
1. Identification / recognition	13	2. Immobilisation / stabilisation / lifting	23
Distinguishing features of Volkswagen models	14	Preventing the vehicle from rolling away	25
Volkswagen logo	14	Switching off the ignition	26
Model designation	14	Lifting the vehicle.....	28
Distinguishing features of vehicles with combustion engine.....	15	3. Disable direct hazards / safety regulations	29
Features on the vehicle.....	15	Opening and closing the bonnet	31
Distinguishing features of high-voltage vehicles.....	16	Deactivating the high-voltage system.....	32
Features on the vehicle.....	16	Identification of emergency cut-out connection.....	34
Classification of the electrification variants	17	Disconnecting the high-voltage system from the vehicle	34
Volkswagen model range with natural gas drive	18	High-voltage cut-out connection on fuse carrier	36
Volkswagen models with natural gas drive (CNG)	18	High voltage cut-out connection in the vehicle front end	36
Distinguishing features of natural gas vehicles	19	High-voltage cut-out connection at the rear of the vehicle.....	37
Exterior features of the vehicle	19	Disconnecting the 12-volt vehicle battery	39
Volkswagen model range with LPG drive	20	Typical fitting locations	40
Distinguishing features of LPG vehicles	20	Disconnecting the 48-volt battery	42

Disconnecting from the charging station (emergency release)	43
Natural gas drive – safety equipment	44
Fuel tank shut-off valve	44
Manually shut off gas tanks	45
Liquefied petroleum gas drive – safety equipment	46
Fuel tank shut-off valve	46
Camping gas equipment – safety equipment	47
Shutting off camping gas cylinders manually	47

4. Access to the occupants 48

Unlocking the vehicle doors	49
Exterior door handles	50
Interior door handles	52
Access via boot lid	53
Electrically operated sliding doors	54
The A-pillar	56
The B-pillar	56
The side members	57
Glazing	58
Tempered safety glass (ESG)	58
Laminated safety glass (VSG)	58
Driver seat and steering wheel adjustment mechanisms	59
Electric convenience systems	60

5. Stored energy / liquids / gases / solids 61

Mainly carried service fluids	62
Warning labels for high-voltage components	63
The high-voltage vehicle electrical system	64
Battery concepts	65
Air conditioning system	68
High-voltage battery – cooling system	68
12-volt electrical system battery	68
Lithium-ion battery (12 and 48 volts)	69
Compressed air tanks	70
Flammable materials	70
Physical properties of natural gas	71
Physical properties of liquefied petroleum gas (also referred to as liquefied gas or LPG)	72
Safety equipment	72
Physical properties of camping gas	73

6. In case of fire 74

General information on vehicle fires	75
Fire in high-voltage vehicles	76
Fire in natural gas vehicles	78
Fire in LPG vehicles	79

7. In case of submersion 80

Vehicle under water	81
High-voltage vehicle under water	81
Natural gas vehicle under water.	82

8. Towing / transportation / storage 83

Recovering vehicles involved in accidents	84
Recovering high-voltage vehicles involved in accidents from a danger area	85
Recovery of natural gas vehicles involved in accidents from a danger area.	87

9. Important additional information 88

Airbag 89	
Front airbag	91
Side airbag	92
Centre airbag	93
Curtain airbag.	93
Airbag stored gas inflators	94
Solid propellant generators	94
Hybrid stored gas inflators	94
Belt tensioners	95
Belt tensioner installation variants	96
Protective bar	100
Re-active bonnet	101
Sources, further information.	101

10. Explanation of pictograms used 102

Pictograms concerning recognition.	103
Pictograms concerning access to the components	104
Pictograms concerning disabling of the vehicle (excluding high voltage)	104
Pictograms concerning access to occupants	106
Worldwide standard symbols.	114
Symbols used in this guide	115

List of abbreviations

ABC	Extinguishing powder for fire classes A, B and C	GTE	Volkswagen models with plug-in hybrid drive
AC	Alternating current	GTI	Volkswagen models with combustion engine (petrol)
AGM	Absorbent Glass Mat	GTX	Volkswagen models with high-voltage drive
BEV	Battery Electric Vehicle	HEV	Hybrid Electric Vehicle
BiFuel	Volkswagen models with liquefied petroleum gas (LPG) drive	ID.	Volkswagen models with high-voltage drive
CAFS	Compressed Air Foam System	ID. family	Volkswagen models with high-voltage drive
CNG	Compressed Natural Gas	ISO	International Organization for Standardization
CO ₂	Carbon dioxide	Li-Ion	Lithium-ion
DC	Direct current	LNG	Liquefied Natural Gas
DGUV	German Statutory Accident and Insurance Association	LPG	Liquefied Petroleum Gas
EcoFuel	Volkswagen models with natural gas drive (CNG)	MHEV	Mild Hybrid Electric Vehicle
eHYBRID	Volkswagen models with plug-in hybrid drive	NiMH	Nickel-metal hydride
ESG	Tempered safety glass	PHEV	Plug-in Hybrid Electric Vehicle,
EV	Electric Vehicle	PKW	Passenger car
FAQ	Frequently Asked Questions	PSA	Personal protective equipment
FBFHB	Fire Service-Assistance-Fire Protection department	R	Volkswagen models with special equipment
FCEV	Fuel Cell Electric Vehicle	SRS	Supplemental restraint system (SRS)
		TGI	Volkswagen models with natural gas drive (CNG)
		TÜV	Technical Inspection Authority
		VDA	German Association of the Automotive Industry

VSG Laminated safety glass

Preface

The vehicle and the surroundings are the key factors whose interaction is critical for road safety.

The vehicle has a number of tasks when an accident occurs, including:

- Keeping the passenger compartment as rigid as possible to ensure a space for survival.
- Dissipating the impact energy using intelligent structural concepts and elements.
- Using an optimised restraint system – consisting of airbags and seat belts with belt tensioners and belt force limiters – to effectively protect the occupants.
- Using safety systems to minimise the hazards from service fluids and powertrain components.

Volkswagen vehicles have proven in international tests that they are among the safest. However, accidents and the associated injuries can never be ruled out. This means a short, fast and effective chain of rescue is as essential as ever.

This includes versions and equipment that Volkswagen offers directly. Retrofit solutions and conversions are not taken into account.

This guide was created in accordance with ISO 17840-3 and is intended to help emergency and recovery personnel do their jobs by providing the necessary information on the technology used in Volkswagen vehicles.

Technical innovations such as new materials or new drive technologies require a modified approach when performing a rescue from a vehicle that has been in an accident. The processes and procedures in the different countries around the world are usually governed by official instructions or guidelines issued by legislators, or the rescue organisation itself. If information about the procedure is provided in this guideline for rescue services, they should be considered as suggestions only for these reasons. The information is intended in particular for the training and development of emergency and recovery personnel. Appropriate rescue cards for Volkswagen vehicles are available for use at the scene of an accident.

The latest version can be found at www.volkswagen.de.

0. Scope of guideline for rescue services



0. Scope of guideline for rescue services

Volkswagen and Volkswagen Commercial Vehicles provide rescue cards for all models and vehicle variants.

The current Volkswagen rescue cards are also available at www.volkswagen.com:

A dynamic search can be used to search for a vehicle model, drive type or language. All European languages are available for vehicles from 2023. Alternatively, an English version can be selected and downloaded.

The illustration shown here includes an example of the first page of the rescue card for the Volkswagen ID.7 in accordance with ISO 17840-1:2022.

	<p>The rescue cards for all Volkswagen models since 2020 are compiled in accordance with ISO 17840 in the current version in each case and may differ from one another. The rescue cards for vehicles before 2020 feature the manufacturer's layout.</p>
	<p>From 2023, all newly created rescue cards will be published in all European languages.</p>



Volkswagen ID.7
Fließheck, ab 2023

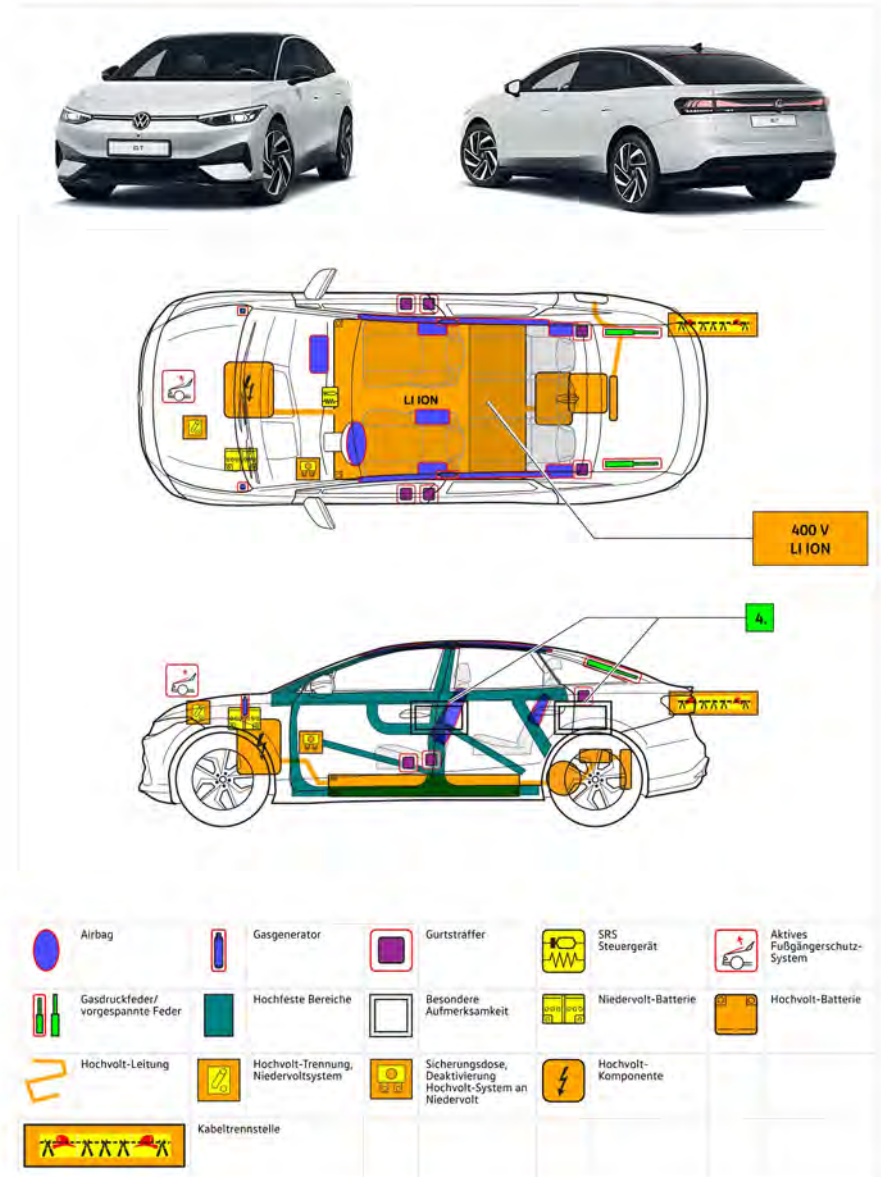

Zusätzliche Informationen

Dokumentnummer
rds_vw_413_111_de

Version
01 (10/2023)

Seite
1 von 4

Area of application

This guide for emergency and recovery personnel is valid for all vehicles made by the Volkswagen and Volkswagen Commercial Vehicles brands.

The range of models is wide, and extends from compact vehicles to light commercial vehicles. The models may be equipped with petrol, diesel and natural gas drives. Hybrid and electric vehicles are equipped with a high-voltage drive. The range of vehicle models may vary from country to country.

Models made by Volkswagen and Volkswagen Commercial Vehicles are shown as examples on this page and the pages that follow.

The current Volkswagen model range can be found at www.volkswagen.de or on the country-specific websites.

Identification of drive types



Petrol vehicle



Diesel vehicle



Petrol-CNG vehicle



Petrol-electric vehicle







Electric vehicle



The vehicle-specific drive types are described on the rescue cards.

Volkswagen range of models

 <p>up!</p>	 <p>Polo</p>	 <p>Taigo</p>
 <p>T-Cross</p>	 <p>ID.3</p>	 <p>ID.4</p>
 <p>ID.5</p>	 <p>ID.7</p>	 <p>Golf</p>
 <p>T-Roc</p>	 <p>T-Roc Cabriolet</p>	 <p>Golf Estate</p>
 <p>Touran</p>	 <p>Tiguan</p>	 <p>Tiguan Allspace</p>

0. Scope of guideline for rescue services

Volkswagen range of models

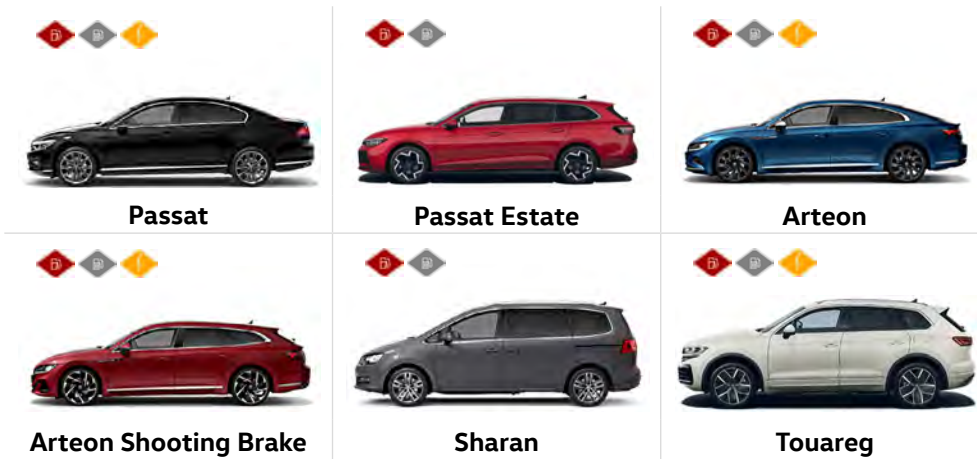

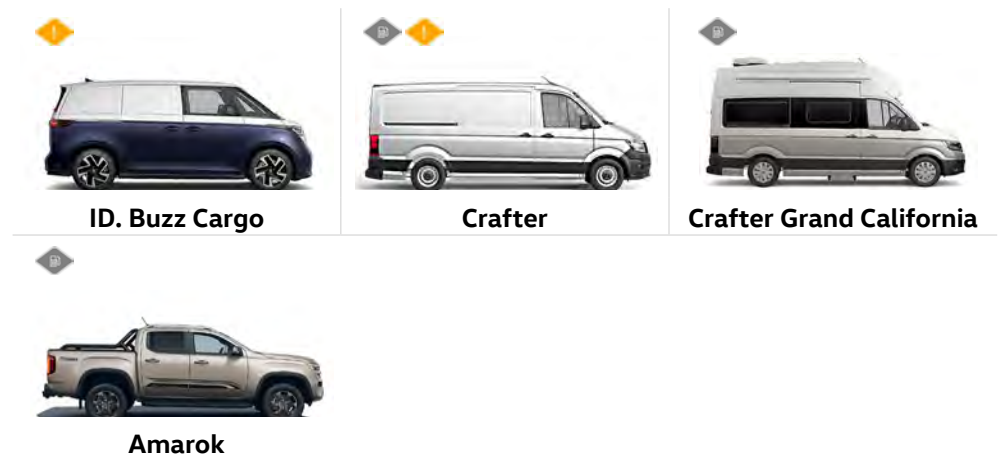

Volkswagen Commercial Vehicles model range



Volkswagen Commercial Vehicles model range



	Volkswagen Commercial vehicles sold the Caddy, Transporter and Caravelle with electric drives in cooperation with the vehicle tuner ABT from 2019 to 2022.
	Volkswagen Commercial Vehicles may exhibit a different body shape to the ones shown here due to individual superstructures and modifications.

1. Identification / recognition

Distinguishing features of Volkswagen models

Recognition of the vehicle model and its drive type plays a central role after an accident. Depending on the vehicle model or drive type, specific procedures must be taken into account as part of a rescue and recovery operation.

Along with the Volkswagen logo, the individual models can be identified by the respective body shape, body size and the individual vehicle design. In addition, the model designation and the technology lettering on the rear of the vehicle can help with identification. This lettering is not present, however, if it was not ordered with the vehicle, or was subsequently removed. The illustrations on this page show examples of how the logo and the lettering are attached.

Volkswagen logo



Volkswagen logo in the radiator grille



Volkswagen logo on the rear lid

Model designation



Model designations on the rear of the vehicle



Model designation on boot lid

Distinguishing features of vehicles with combustion engine

Volkswagen models with conventional combustion engines (petrol/diesel) can be identified by the following features.



The vehicle-specific distinguishing features are described on the rescue cards.

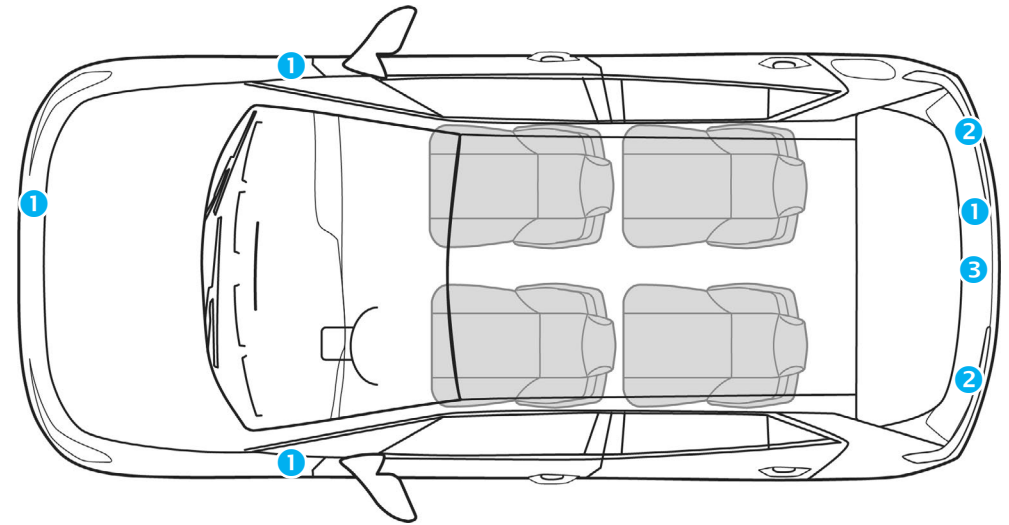



Features on the vehicle

- ❶ Model-specific lettering such as "GTI", "GTD" or "eTSI"
- ❷ Visible exhaust system
- ❸ Model designation centrally under the Volkswagen badge

Distinguishing features of high-voltage vehicles

Volkswagen models with a high-voltage drive are available with plug-in hybrid drive (PHEV) or a fully electric drive (BEV).

	<p>The electric drive motor is silent. The display in the dash panel insert (power display) provides feedback as to whether the electric drive is switched to OFF, or READY for operation.</p>
	<p>The vehicle-specific distinguishing features are described on the rescue cards.</p>

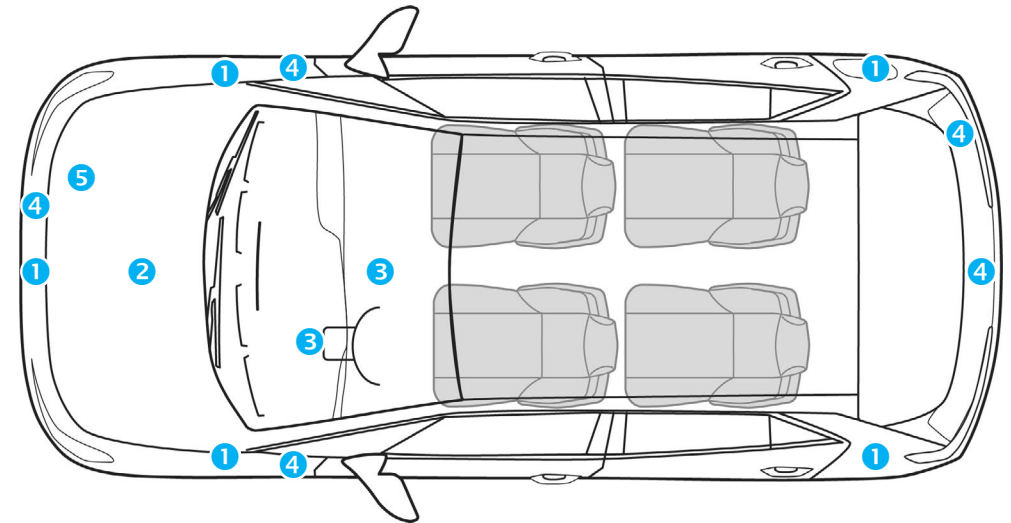

Features on the vehicle

- ❶ Charging sockets in the radiator grille or in the front or rear wings
- ❷ Orange-coloured cables in the vehicle front end
- ❸ E-specific displays on the instrument cluster such as charging displays, power display "READY" for driving readiness, "E-Mode" button in the centre console, Sport program button (GTE)
Hybrid or GTE lettering, e.g. on the cockpit and/or steering wheel
- ❹ "GTE", "eHYBRID", "ID." or "GTX" lettering on the boot lid or radiator grille as well as at the sides on the wings (lettering may be missing)
- ❺ Warning sticker in the vehicle front end

1. Identification / recognition

Classification of the electrification variants

After an accident, electrified vehicles pose different hazards to emergency and recovery services than those presented by conventionally powered vehicles. This makes it crucial to identify these vehicles as soon as possible.

Volkswagen offers various electrification variants, which differ in terms of primary energy source, voltage, type of driving machine and electric range.

A distinction is made between the following variants without external charging socket:

- Mild-Hybrid Electric Vehicle (MHEV)
- Full-Hybrid Electric Vehicle (HEV)



and the following variants with external charging socket:



- Plug-In Hybrid Electric Vehicle (PHEV)
- Battery Electric Vehicle (BEV)

The different electrification concepts are shown in the table. Mild hybrid vehicles (MHEV) with on-board electrical system voltages of up to 48 volts are not high-voltage vehicles. These vehicles also do not differ externally from the conventional Volkswagen vehicles of the respective model.

All other variants listed are high-voltage vehicles.

Key for energy sources

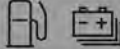
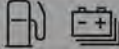
	Conventional fuels such as petrol and diesel
	Battery operation
	Battery operation with charging option via socket

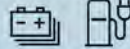
	Mild hybrid (MHEV)	Full hybrid (HEV)	Plug-in hybrid (PHEV)	Battery Electric Vehicle (BEV)
Voltage	12-48 V	200-300 V	300-450 V	300-950 V
Electric drive motor	10-15 kW	20-50 kW	60-120 kW	> 150 kW
Electric driving range		approx. 3 km	approx. 50 km	> 200 km
Energy source				
Models (examples)	Golf Tiguan Passat	Jetta Hybrid Touareg Hybrid	Golf GTE, eHYBRID Tiguan eHYBRID Passat GTE Arteon eHYBRID Multivan eHYBRID Touareg R, eHYBRID	e-up! e-Golf e-Crafter ID. family



Volkswagen model range with natural gas drive



A number of points distinguish vehicles with natural gas drive (CNG) from conventional vehicles and vehicles with a liquefied petroleum gas drive. Knowledge of these differences is highly significant for the rescue operations.

Volkswagen offers a range of vehicle models with petrol/natural gas drive as "TGI" vehicles. Other vehicles with natural gas drive were sold with the designation "EcoFuel". Vehicles with liquefied petroleum gas (LPG) drive feature the designation "BiFuel".

The natural gas vehicles made by Volkswagen also have a small fuel tank for petrol installed along with various natural gas tanks.

Being able to identify natural gas vehicles immediately is of critical importance for emergency and recovery personnel deployed e.g. to traffic accidents in order to allow them to assess the risks at the scene of deployment and take appropriate measures.

	<p>Natural gas (also referred to as CNG – compressed natural gas) must not be mistaken for LPG – liquefied petroleum gas. Liquefied petroleum gas and autogas systems are fundamentally different to natural gas and natural gas systems.</p>
	<p>The term "BiFuel" was also used for natural gas vehicles when vehicles with a gas drive were introduced. The term "EcoFuel" has been used for natural gas vehicles and the term "BiFuel" has been used for liquefied petroleum gas vehicles since 2009. Current vehicles with a natural gas drive are sold under the designation "TGI".</p>

	<p>Further information on natural gas vehicles can be found in chapter 3. Disable direct hazards / safety regulations, chapter 5. Stored energy / liquids / gases / solids, chapter 6. In case of fire, chapter 7. In case of submersion and chapter 8. Towing / transportation / storage.</p>
	<p>Dealing with natural gas vehicles is different to dealing with conventional vehicles. However, any dangers can be controlled appropriately and to the same extent if the special points to note are known.</p>

Volkswagen models with natural gas drive (CNG)

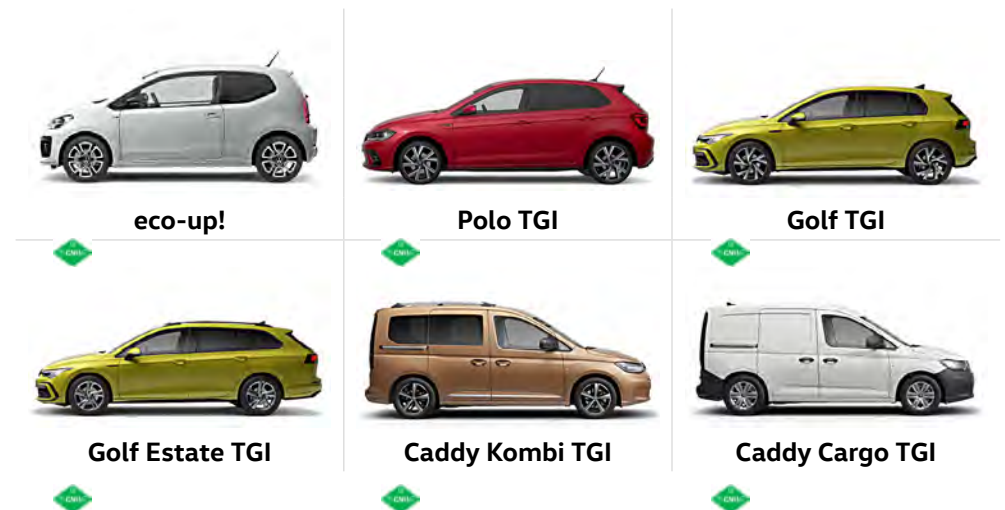

Distinguishing features of natural gas vehicles

Exterior features of the vehicle

- Lettering on the rear lid
- Separate natural gas connection, integrated behind the tank cap

Exterior features of the vehicle



"TGI" lettering on boot lid (lettering may be missing)



Natural gas connection at the fuel filler neck



Volkswagen model range with LPG drive

A number of points distinguish vehicles with a liquefied petroleum gas drive – also designated as LPG or liquefied gas – from conventional vehicles. Knowledge of these differences is very important for emergency personnel when performing a rescue operation.

Volkswagen currently does not offer any vehicles with a liquefied petroleum gas (LPG) drive. Vehicles with LPG drive were offered up to April 2014.

All vehicles made by Volkswagen with a liquefied petroleum gas drive can be operated using both liquefied petroleum gas and petrol. The BiFuel vehicles feature a bivalent drive system, i.e. the conventional series petrol tank is installed along with the liquefied petroleum gas tank.

Being able to identify liquefied petroleum gas vehicles immediately is of critical importance for emergency and recovery personnel deployed, e.g. to traffic accidents, in order to allow them to assess the risks at the scene of deployment and take appropriate measures.



	<p>Liquefied petroleum gas (also designated as LPG or liquefied gas) must not be mistaken for natural gas (also designated as CNG or compressed natural gas). Natural gas and natural gas systems have features that fundamentally distinguish them from liquefied petroleum gas and autogas systems.</p>
	<p>Dealing with liquefied petroleum gas vehicles is different to dealing with conventional vehicles. However, any dangers can, so to speak, be appropriately brought under control when knowledge of their special features is available.</p>

Distinguishing features of LPG vehicles

No vehicles with a liquefied petroleum gas drive are currently being sold, however a range of different Volkswagen models can be found on the road.

Exterior features of the vehicle

- "BiFuel" lettering on the boot lid
- Separate LPG connection

Exterior features of the vehicle	
	<p>"BiFuel" lettering on the boot lid</p>
	<p>LPG or liquefied gas tank in the luggage compartment floor</p>
	<p>Liquefied gas connection at tank filler neck</p>

Volkswagen Commercial Vehicles with camping gas equipment

Volkswagen Commercial Vehicles offers a range of models with additional camping gas equipment.

Different types of camping gas cylinders (propane or butane) are installed at different positions in the vehicle in these models.

Being able to identify vehicles with camping gas equipment immediately is of critical importance for emergency and recovery personnel deployed, e.g. to traffic accidents, in order to allow them to assess the risks at the scene of deployment and take appropriate measures.

Current Volkswagen Commercial Vehicles with camping gas equipment



Caddy California
1 × 1.8 kg gas cylinder



California Beach
1 × 1.8 kg gas cylinder





California Coast/Ocean
1 × 11 kg gas cylinder



Grand California 600
2 × 11 kg gas cylinder



Grand California 680
2 × 11 kg gas cylinder

 	<p>Propane or butane gas is highly flammable.</p>
	<p>Dealing with vehicles with camping gas equipment is different to dealing with conventional vehicles. However, any dangers can, so to speak, be appropriately brought under control when knowledge of their special features is available.</p>

Distinguishing features of camping gas vehicles

Exterior features of the vehicle

- TÜV inspection sticker on boot lid
- Special roof structure (optional)
- Awning on front passenger side (optional)
- "California" lettering (lettering may be missing)

Features in the vehicle interior

- Kitchen with one or two gas hobs
- Basin
- Shower cabin
- Toilet
- Up to four beds

Some of the above equipment is available as an option.

Exterior features of the vehicle



TÜV inspection sticker



Special roof structure



Awning on front passenger side

Features in the vehicle interior (examples)



Extendable mini kitchen at the rear of the vehicle for the Caddy California



Kitchenette with basin on the driver side in the California



Kitchen with a basin accessible from the outside on the passenger side for the Grand California

2. Immobilisation / stabilisation / lifting

Stabilising or securing a vehicle reduces the risks that may result from unwanted movements of the vehicle after an accident.

The modern vehicle systems such as start/stop system or Auto Hold function (HOLD button) or new silent drive systems convey the impression that the vehicle is switched off.

However, depending on the accident situation, these systems could lead to the vehicle starting and rolling away unintentionally.

It is therefore recommended to ensure that the ignition is OFF or the power meter is OFF before starting the rescue operation and to thus deactivate the vehicle's drive system. For more information, see chapter 3. [Disable direct hazards / safety regulations](#).

Depending on the situation, it is also recommended to secure the vehicle against unwanted movements (rolling, tilting, slipping) by means of wheel chocks, suitable supports or the attachment of slings.



When the 12-volt vehicle battery has been disconnected, all functions of the electrical system stop working (this applies in particular to the hazard warning lights, interior lighting and electric seat adjustment).

For further information, see chapter 4. [Access to the occupants](#) and chapter 9. [Important additional information](#).



The vehicle's drive system is automatically deactivated after an accident with triggering of the airbags has been identified in vehicles in the ID. family.



In high-voltage vehicles, it is recommended to always locate an accessible high-voltage device that disconnects high voltage to de-energise the high-voltage system. Also see chapter 3. [Disable direct hazards / safety regulations](#).



The vehicle-specific rescue cards describe the recommended procedure for deactivating the high-voltage cut-out connections.

Preventing the vehicle from rolling away

Volkswagen models may be equipped with a manual gearbox or an automatic gearbox.

To prevent the vehicle from rolling away or moving off accidentally, the gear lever must first be placed in the "Neutral" (for a manual gearbox) or in the "P" position for automatic gearboxes, depending on the accident situation.

1. Select the correct/appropriate gear
2. Locate parking brake
3. Apply the parking brake



If necessary, secure the vehicle with suitable wheel chocks to prevent it from rolling away unintentionally or secure it with belts.



Conventional vehicle with automatic gearbox: apply electronic parking brake or pull handbrake lever.



Apply the electronic parking brake at the right steering column switch.



Vehicle with manual gearbox and manual handbrake.

If further securing methods are necessary, the following vehicle areas can be used for this: vehicle pillars, members, wheels, axles, towing eyes or optionally the ball coupling.

Switching off the ignition

Turn the ignition key to "OFF" and remove it. Many Volkswagen models are equipped with a START-ENGINE-STOP button. This may be located on the steering column, in the centre console or in the dash panel.

The following possibilities, amongst others, must be kept in mind:

- The vehicle may still have a traditional ignition lock or it may have Keyless Entry, a system where the ignition key can switch on the vehicle from anywhere inside it (e.g. in the driver's pocket or a handbag in the vehicle). Some vehicles can also be controlled using an app.
- Use the ignition key, if there is one, to switch the vehicle to OFF.

If the vehicle features a START-ENGINE-STOP button that can be used to deactivate the vehicle, press this.

Then remove the remote control key, key card or smartphone from the vehicle and keep at a minimum distance of five metres to prevent unintentional switching on.

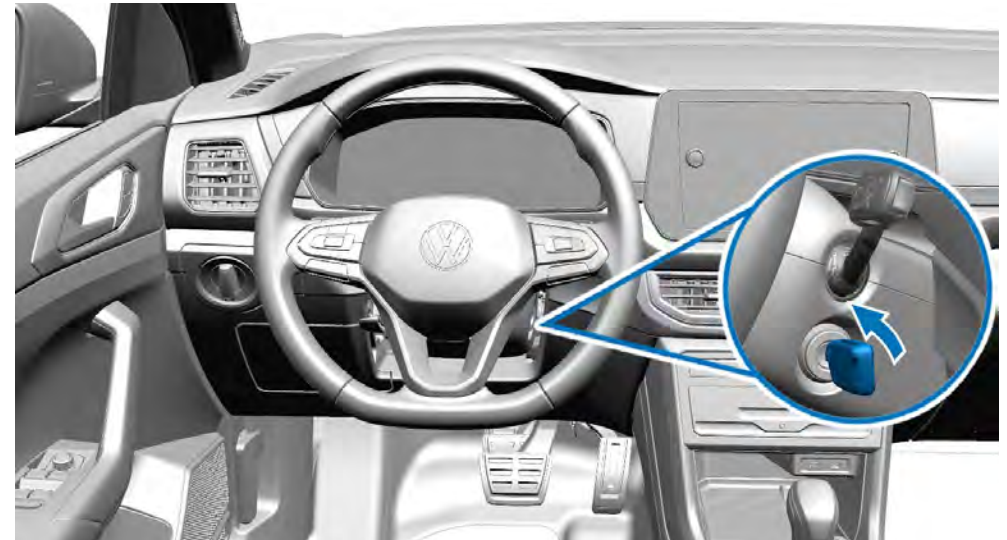

Vehicle with conventional key.





Vehicle with START-ENGINE-STOP button in the centre console.

2. Immobilisation / stabilisation / lifting







Vehicle with START-ENGINE-STOP button on the steering column.

	<p>Instead of the ignition key, use of a key card or smartphone app is also possible. Remove the ignition key, the key card or the smartphone from the vehicle (a minimum distance of five metres should be observed for this).</p>
	<p>If the START-ENGINE-STOP button is pressed and the brake pedal is simultaneously operated, the vehicle may switch to driving readiness mode. Observe the information on the rescue cards.</p>
	<p>In vehicles with high-voltage drive, the "power display" in the instrument cluster provides feedback as to whether the electric drive is switched off OFF or ready for operation READY.</p>

Lifting the vehicle

Lifting the vehicle may be necessary to rescue injured persons. Make sure that sensitive parts such as the high-voltage battery, drive train, fuel tank or exhaust system are not damaged if possible.

	Use firmly anchored components when lifting or securing vehicles that have been involved in an accident. Do not use high-voltage components or exhaust systems.
	For deformed vehicles, the emergency and recovery personnel on site must decide at which points to lift the vehicle.
	The vehicle-specific points for lifting are indicated on the rescue cards.
	If possible, lift the vehicle at the indicated lifting points.

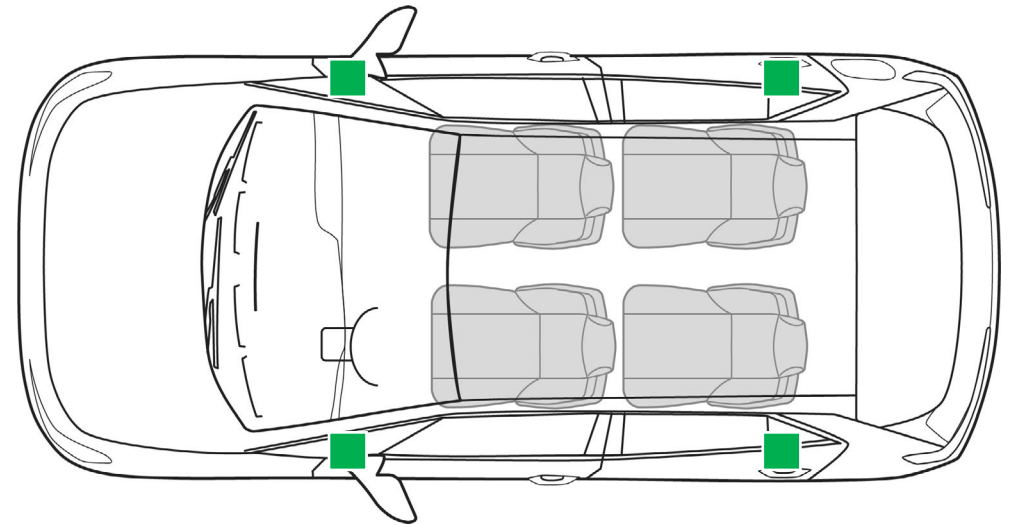

3. Disable direct hazards / safety regulations

Recognition and elimination of hazards to life and limb plays a major role in dangerous situations. This chapter describes the appropriate preventive measures that minimise the risks to accident victims and rescue personnel.



Wear appropriate protective clothing as liquids or gases may leak and cause injury or explosion.
Avoid contact with these substances as much as possible during rescue and recovery operations.

In hazard situations, the following procedure is recommended:

1. Warn surroundings about hazards
(switch on hazard warning lights, are activated automatically after an accident)
2. Immobilise the vehicle, see chapter [2. Immobilisation / stabilisation / lifting](#)
3. De-energising the vehicle electrical system
[Deactivating the high-voltage system](#)
[Disconnecting the 12-volt vehicle battery](#) (depending on situation)
[Disconnecting the 48-volt battery](#)



In the event of an accident in which airbags are triggered, the high-voltage system and the 48-volt electrical system are automatically deactivated.
The high-voltage system is de-energised approx. 20 seconds after deactivation.

Opening and closing the bonnet

Depending on the situation, it may be necessary to open and close the bonnet. The following section describes the standard procedure (the 2-lock system is not taken into account).



Further information can be found in the vehicle-specific Owner's Manuals.



In the footwell on the driver's side: release lever for the bonnet (example ID.4).

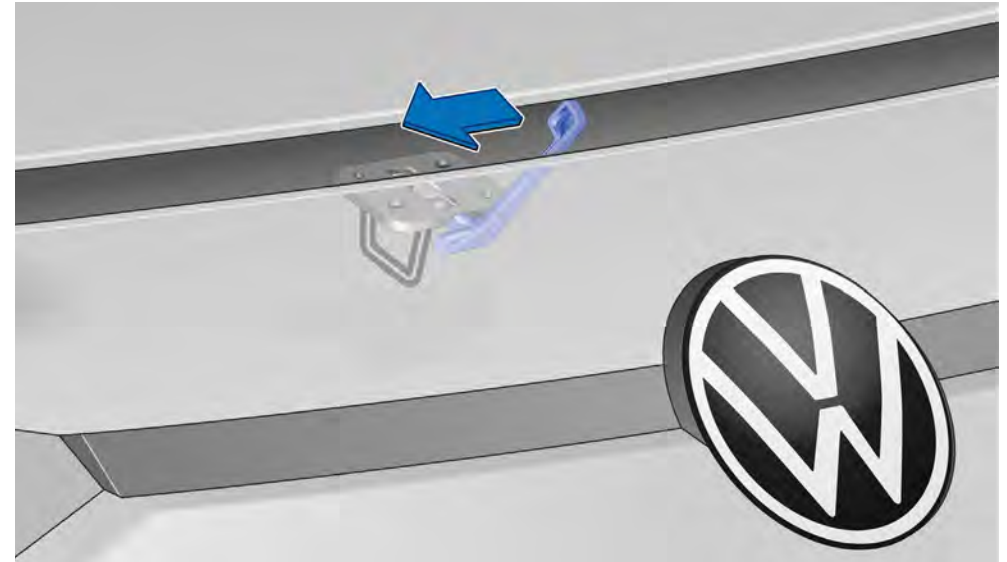

On the bonnet: opening lever (example ID.4).

Deactivating the high-voltage system



Volkswagen models with battery-electric drive (BEV) or plug-in drive (PHEV) are equipped with a high-voltage system with a voltage of over 300 volts.

The high-voltage system is disconnected from the high-voltage battery immediately when triggering of the airbags is detected. Activation of the high-voltage system can then only be performed by a suitable qualified workshop. In addition, displays or warnings can be displayed on the dash panel.

High-voltage vehicles from Volkswagen have several emergency cut-out connections. These are located on the fuse box, in the vehicle front end or at the rear of the vehicle. They provide emergency personnel with an easily accessible way of safely deactivating the high-voltage system. Further information is provided on the following pages under [Disconnecting the high-voltage system from the vehicle](#).

	<p>The electric drive motor is silent in vehicles with a high-voltage drive. The display in the instrument cluster (power meter) indicates whether the electric drive is switched off (OFF) or ready for operation (READY).</p>
	<p>The vehicle's drive system can be activated by occupying the driver seat and pressing the brake pedal in vehicles in the ID. family.</p>



	<p>In the event of accidents in which airbags are triggered, the high-voltage system is automatically deactivated. The high-voltage system is de-energised approx. 20 seconds after deactivation.</p>
	<p>In all other cases, an emergency cut-out connection can be used to deactivate the high-voltage system. In particular, using an emergency cut-out connection prevents the system from switching on again unintentionally.</p>

Depending on the circumstances of the accident and the situation at the scene of the accident, the prioritised emergency cut-out connection in the fuse box may not be accessible (e.g. in the event of a car/truck underride accident). If necessary, the alternative emergency cut-out connection in the vehicle front end or at the rear of the vehicle can be used.

These emergency cut-out connections indicated by yellow tags only carry the 12-volt electrical system voltage, which means they can be safely disconnected by the emergency personnel using the procedure described on the tags.

	<p>Disconnection of a marked emergency cut-out connection only disables the high-voltage system. Safety systems such as airbags or belt tensioners are still supplied with voltage by the 12-volt electrical system.</p>
	<p>If the airbag has not been triggered, the 12-volt electrical equipment may still be supplied with electrical energy from the high-voltage battery via the DC converter after the electrical system battery has been disconnected!</p>
	<p>Even after deactivating the high-voltage system, there is still energy inside the high-voltage battery. The high-voltage battery must therefore neither be damaged nor opened during the rescue measures.</p>

3. Disable direct hazards / safety regulations

	Do not touch damaged high-voltage components, and cover them using suitable means if necessary! Wear personal protective equipment in accordance with the local standards!
	The positions of the emergency cut-out connections and the procedure for disabling the vehicle are shown on the Volkswagen rescue cards.

At the scene of the accident

Depending on the accident situation, restraint systems, e.g. airbags, may have been triggered. The emergency and recovery services at the scene of the accident decide how to proceed with the rescue and recovery.

	Rapid or strong smoke development on the accident vehicle may indicate a thermal reaction of the high-voltage battery, see also Is the high-voltage battery affected by the fire? .
---	---

Minor accident



Initially, no damage is visible and the restraint systems have not been deployed.

1. Warn surroundings of hazards
Switch on hazard warning lights, set up warning triangle
2. Immobilise vehicles
[2. Immobilisation / stabilisation / lifting](#)
3. Deactivate the high-voltage system by removing the fuse at the fuse carrier or disconnecting alternative emergency cut-out connections

Severe accident

The restraint systems were triggered. There is initially no visible damage to the high-voltage battery.

1. Warn surroundings of hazards
Switch on hazard warning lights, set up warning triangle
2. Immobilise vehicles
[2. Immobilisation / stabilisation / lifting](#)
3. The high-voltage system was deactivated automatically

	Damage or deformation of the high-voltage battery on the accident vehicle may indicate a thermal reaction of the high-voltage battery, see also Is the high-voltage battery affected by the fire? .
	Depending on the accident situation, it may be necessary to additionally deactivate the high-voltage system manually at an emergency cut-out connection.

Parked or stationary vehicle

If a parked vehicle is damaged by an accident, restraint systems or airbags are generally not triggered. The high-voltage system is not automatically deactivated. When the ignition is switched off, no warnings can be displayed on the dash panel.

1. Deactivate the high-voltage system by removing the fuse at the fuse carrier.

Vehicle at charging station

If a charging vehicle is damaged by an accident, restraint systems or airbags are generally not triggered. The high-voltage system is not deactivated automatically. When the ignition is switched off, no warnings can be displayed on the dash panel.

1. Disconnect charging cable as usual (see Owner's Manual of the vehicle).
2. Alternatively, [Disconnecting from the charging station \(emergency release\)](#).

3. Disable direct hazards / safety regulations



The high-voltage components are marked with warning signs, see also [Warning labels for high-voltage components](#). High-voltage cables are orange.

Identification of emergency cut-out connection

The emergency cut-out connections for deactivating the high-voltage system are uniformly marked on the models in the Volkswagen Group. The pictograms on the labels explain the procedure.

Until 2022, the labels were produced according to our own specifications and installed in the models. With the introduction of the ID.7, new labels coordinated with EURO NCAP will be used. These labels will also be used for all models in the Volkswagen Group in the future.

Previous identification



Indicates the emergency cut-out connection in the passenger compartment (pulling out the fuse on the fuse carrier)

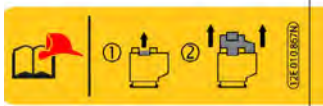

Indicates the emergency cut-out connection in the vehicle front end (opening the maintenance connector for high-voltage system)



Indicates the emergency cut-out connection in the luggage compartment or rear of the vehicle (cutting through the marked cable)

New identification as of ID.7

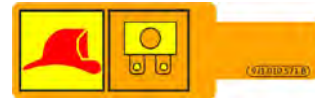

Indicates the emergency cut-out connection in the passenger compartment (pulling out the fuse on the fuse carrier)



Indicates the emergency cut-out connection in the vehicle front end (opening the maintenance connector for high-voltage system)



Indicates the emergency cut-out connection in the luggage compartment or rear of the vehicle (cutting through the marked cable)

Disconnecting the high-voltage system from the vehicle



The electric drive motor is silent in vehicles with a high-voltage drive. The display in the instrument cluster (power meter) indicates whether the electric drive is switched off (OFF) or ready for operation (READY).
Observe the information on the rescue cards.



If the high-voltage system is also to be disconnected manually, observe the following sequence:

1. First use the [High-voltage cut-out connection on fuse carrier](#); if this cannot be reached, then use the
2. [High voltage cut-out connection in the vehicle front end](#) maintenance connector for high-voltage system or
3. [High-voltage cut-out connection at the rear of the vehicle](#) .

3. Disable direct hazards / safety regulations





There are at least two cut-out connections in current Volkswagen models. One is in the fuse carrier and another is installed in the vehicle front end. There is an additional third cut-out connection in the rear of the vehicle in some vehicles in the ID. family.

Different procedures may be necessary, depending on the vehicle type and equipment. The way in which the vehicle is disabled depends on the accident situation and the vehicle equipment.

	<p>The installation location of the emergency cut-out connections and the required procedures can be found on the Volkswagen rescue cards.</p>
	<p>Maximum certainty that the high-voltage system is deactivated can only be provided if an emergency cut-out connection provided by the manufacturer is disconnected and the 12-volt vehicle electrical system battery is disconnected.</p>

Use rescue equipment with caution and consideration near high-voltage components

Regardless of whether the vehicle is a hybrid or electric vehicle, the following points always apply in rescue operations at high-voltage vehicles.

	<p>Improper handling of high-voltage components can prove fatal due to high voltage and the associated potential flow of current through the human body.</p>
	<p>Do not perform any work on badly damaged high-voltage components. One of the accessible emergency cut-out connections should also be opened.</p> <p>If the airbags have not deployed, the vehicle must be disabled by the emergency and recovery personnel using an emergency cut-out connection. The high-voltage system has been de-energised after approx. 20 seconds.</p> <p>If the airbags have deployed, the high-voltage system will have already been switched off; this means the emergency and recovery personnel can act immediately.</p>
	<p>Even after disabling the high-voltage system, there is still electrical energy inside the high-voltage battery. The high-voltage battery must therefore neither be damaged nor opened during the rescue measures.</p> <p>If the high-voltage battery has been damaged due to the effects of an accident, avoid any contact with the high-voltage battery or with any liquids and vapours escaping from the high-voltage battery.</p>
	<p>Do not touch damaged high-voltage components, and cover them using suitable means if necessary!</p> <p>Wear personal protective equipment in accordance with the local standards!</p>

High-voltage cut-out connection on fuse carrier

Depending on the vehicle model, the fuse carrier is located in the interior in the area of the dash panel or installed at the rear of the vehicle and marked with a yellow tag. In this case, the high-voltage system is disconnected and deactivated by pulling the appropriately labelled fuse out of its holder.

The connectors in the high-voltage battery open and disconnect it from the rest of the high-voltage system, which is then de-energised after 20 seconds have passed.

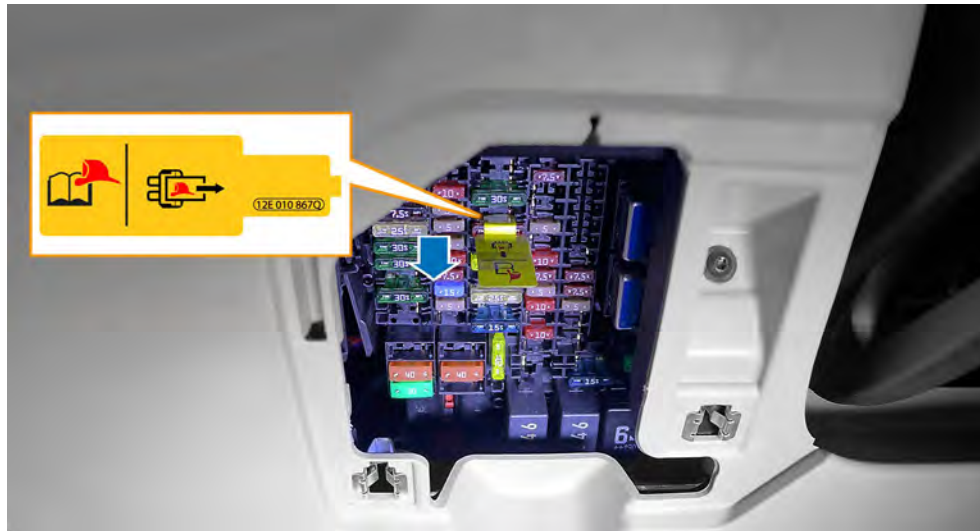

Cut-out connection in the passenger compartment, dash panel on the fuse carrier, see also [New identification as of ID.7.](#)

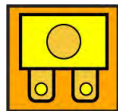

Identification/pictogram of the emergency cut-out connection on the fuse carrier on the rescue card

High voltage cut-out connection in the vehicle front end

The low-voltage maintenance connector for the high-voltage system in the vehicle front end is used as an emergency cut-out connection for high-voltage systems in plug-in hybrid electric vehicles (PHEV) and electric vehicles (BEV). The connector has a green connector housing and a tab for release. The connector is clearly identified as an emergency cut-out connection by a yellow label on the connection cable. Activation after this can only be carried out by a suitable qualified workshop.

The vehicle front end is usually accessed by pulling the Bowden cable in the left front footwell. This unlocks the bonnet, which can then be raised. Please refer to the Owner' Manual of the vehicle if necessary.

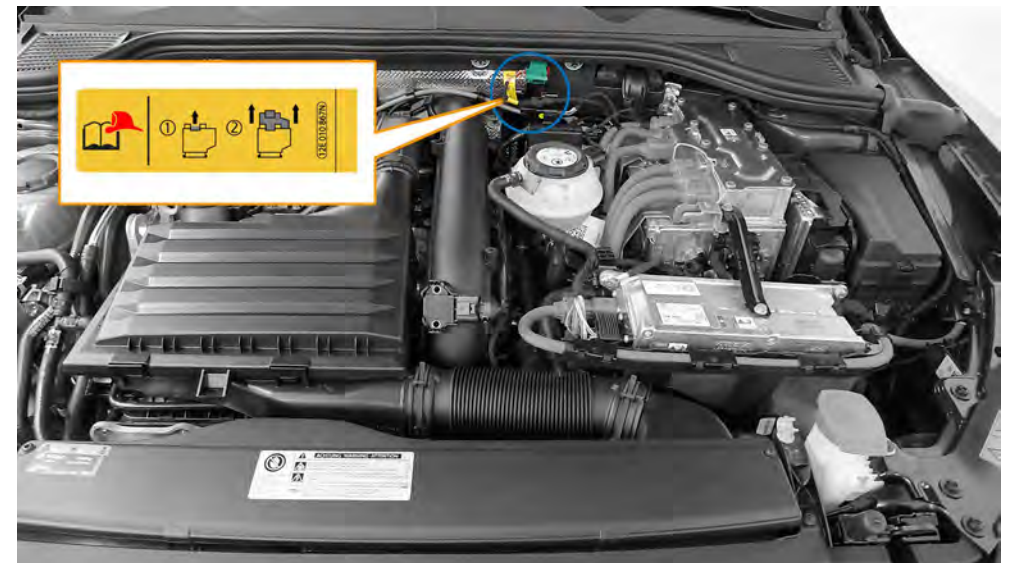

Cut-out connection in the front end of hybrid vehicles (Golf GTE from 2020), see also [New identification as of ID.7.](#)



Identification/pictogram of the emergency cut-out connection on the rescue card

3. Disable direct hazards / safety regulations



If the label of the emergency cut-out connection in the vehicle front end is not visible, an additional sticker may be attached nearby.

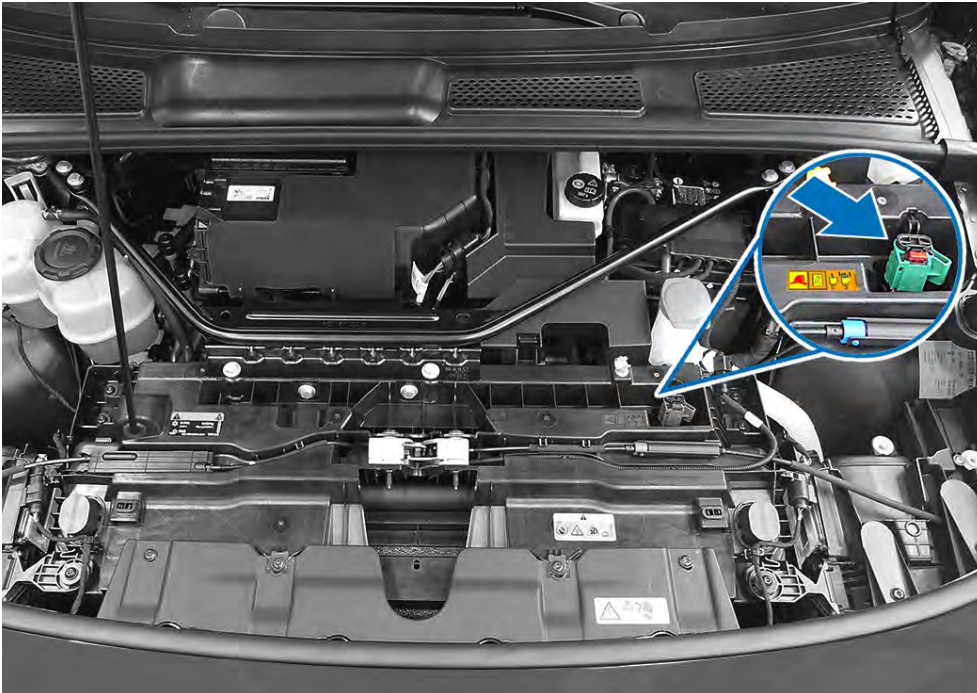

Cut-out connection in front end of electric vehicle (ID.3), see also [New identification as of ID.7](#).

Procedure for deactivating the high-voltage system using the emergency cut-out connection:



Pull out the red tab



Press and hold the red tab and, while doing so, pull the back connector until it locks in position.

High-voltage cut-out connection at the rear of the vehicle

For vehicles in the ID. family, there may be an additional cut-out connection in the rear of the vehicle. In this case, a cable labelled with a yellow tag must be cut.

The high voltage device that disconnects high voltage was installed behind the luggage compartment trim up to production date 12/2020; it has been behind the right tail light cluster since 01/2021.

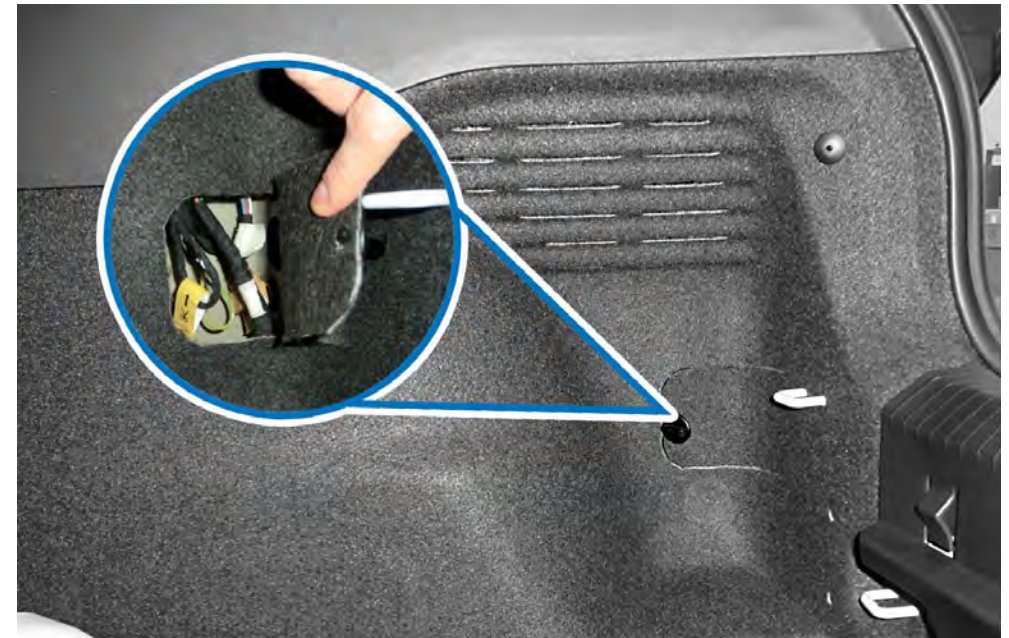

Version 1: Cut-out connection in the luggage compartment (example ID.3) behind the side panel trim until the end of 2020. The yellow tag indicates the cut-out connection.



Identification/pictogram of the emergency cut-out connection at the rear of the vehicle on the rescue card

3. Disable direct hazards / safety regulations

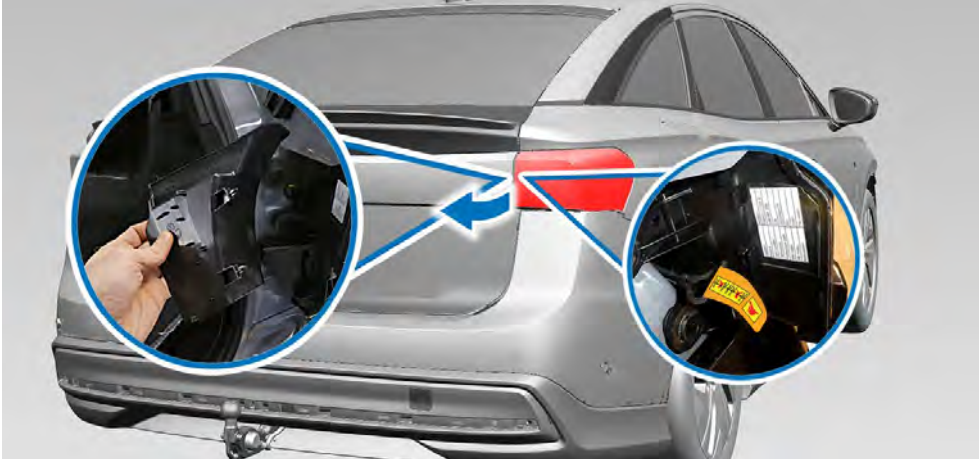

Variant 2: alternatively, the trim under the tail light can be unclipped and the cut-out connection cut, see also [New identification as of ID.7.](#)

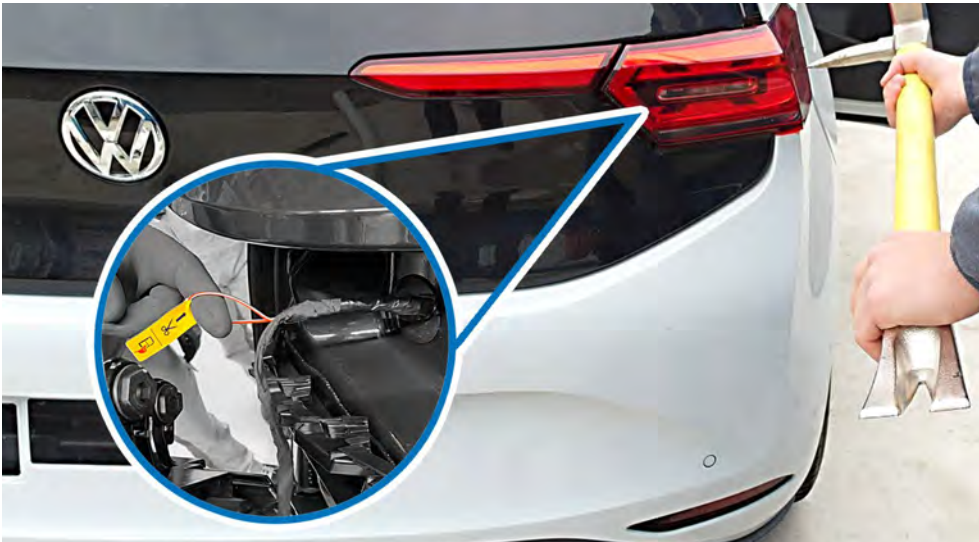

Variant 2: cut-out connection in the rear of the vehicle behind the right tail light cluster from the start of 2021 onwards.



Disconnecting the 12-volt vehicle battery



Situations at the scene of an accident may require the 12-volt vehicle electrical system to be deactivated in order to reduce the risks to accident victims or emergency services (e.g. subsequent triggering of airbags).

Depending on the type of vehicle and equipment, one or more 12-volt vehicle batteries may be installed.

Disabling the vehicle electrical system not only reduces the risk of fire caused by short circuits, but also the risk of delayed deployment of airbags, belt tensioners or protective bars.

When deactivating the vehicle electrical system, it must also be ensured that the power supply to any trailers attached is disconnected and any solar elements in the sliding sunroof are covered.

	<p>If several vehicle electrical system batteries are installed, all must be disconnected so that the vehicle is de-energised.</p>
	<p>For vehicles where access to the vehicle electrical system battery is not possible: Volkswagen has installed an accessible ground cable from the battery to the body; disconnect this. Always insulate the ground cable after disconnecting it to reduce the risk of arcing.</p>

	<p>Always disconnect the negative terminal from the battery first and then the positive terminal. To avoid the risk of arcing, the battery terminals should be insulated.</p>
	<p>When the 12 V supply has been disconnected, all functions of the electrical system stop working (this applies in particular to the hazard warning lights and electric seat adjustment). Further information in chapter 4. Access to the occupants and chapter 9. Important additional information must be observed.</p>
	<p>The fitting location and procedure necessary for deactivating the 12-volt vehicle electrical system voltage is described in the Volkswagen rescue cards.</p>

Typical fitting locations

Depending on the requirements, the 12-volt vehicle electrical system battery is located in the vehicle front end, in the luggage compartment or in the passenger compartment. A second 12-volt battery may also be installed at a different location in the vehicle.

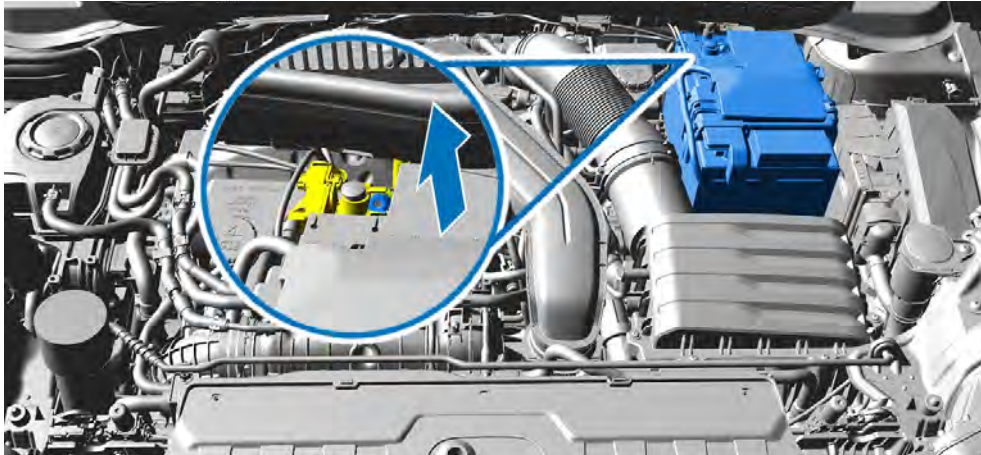

Location in the vehicle front end (example T-Cross 2023).



Location in the luggage compartment (example Golf GTE).



Location in the luggage compartment (example Tiguan).



Location in the passenger compartment (example Touareg 2023).

3. Disable direct hazards / safety regulations

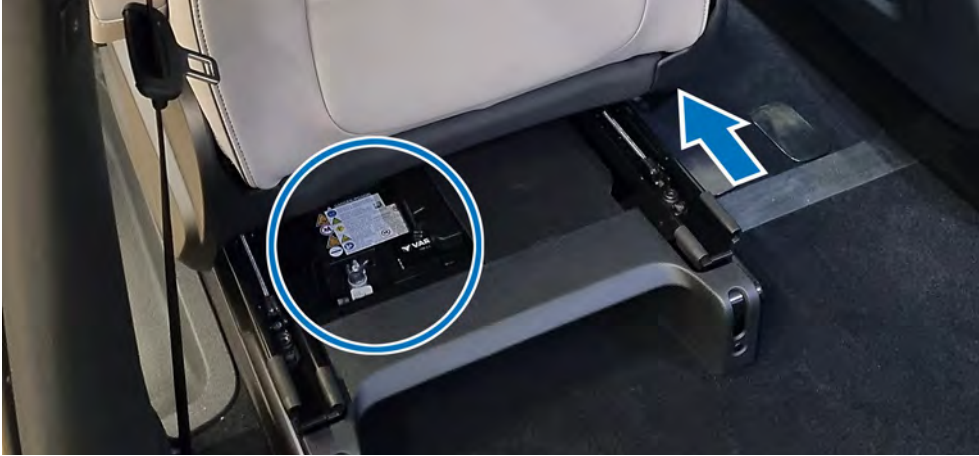

Location in the passenger compartment under the driver seat (example ID. BUZZ).

Disconnecting the 48-volt battery





Today's vehicles feature intelligent drive systems and a variety of driver assist systems. A number of them are operated using an additional 48-volt electrical system that is installed.





Volkswagen models with a 48-volt electrical system are also referred to as mild hybrid vehicles (MHEV) and are marketed as eTSI models. These vehicles are not high-voltage vehicles.

A number of examples of use are:

- Rear wheel steering
- Roll stabilisation
- Advanced start/stop mode with help from a belt-driven starter-alternator

	<p>In the event of an accident in which airbags are triggered, the 48-volt electrical system is automatically disabled.</p>
	<p>The 48-volt vehicle electrical system must be disconnected in order to de-energise the vehicle.</p>

The specific danger associated with the 48-volt voltage level can be controlled appropriately and to the same extent as with conventional 12-volt electrical system batteries if the special points to note are known.

	<p>When disconnecting the 48-volt battery, there is a danger of an electric arc! Wear appropriate personal protective equipment!</p>
	<p>Lithium-ion batteries can self-ignite either immediately or after a delay when damage occurs or they are not used properly, or re-ignite after fire-fighting measures. Wear appropriate personal protective equipment!</p>
	<p>A 48-volt capacitor is installed on the right side of the rear of the vehicle in a number of Touareg models with roll stabilisation. Orange coloured wires lead to the component.</p>
	<p>The procedure for disconnecting the 48-V battery is described in the rescue cards.</p>

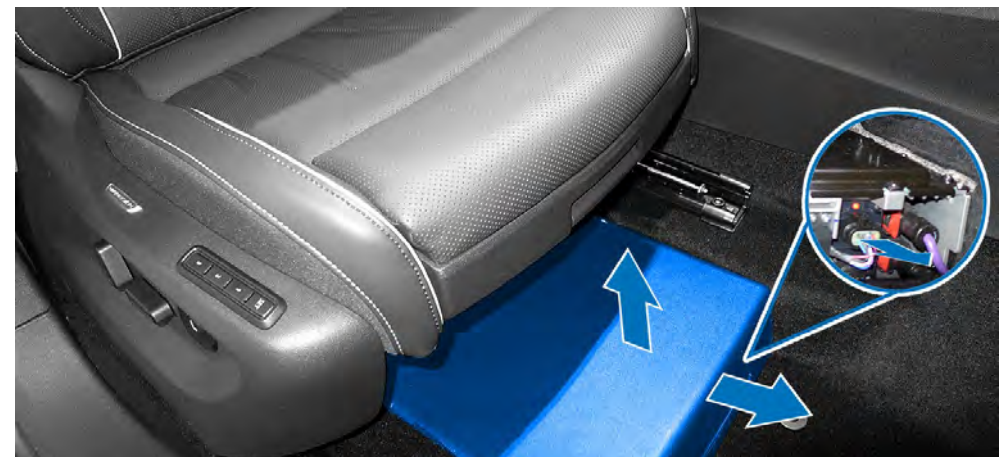

Disconnecting the 48-volt vehicle electrical system in a Tiguan from 2023 onwards.

Disconnecting from the charging station (emergency release)

Vehicles parked at a charging station or wall box for charging can be disconnected from these in an emergency.

If regular disconnection is not possible, the vehicle can be released manually using the action described on the rescue card. The manual release is always located on the rear of the charging socket.



The procedure for operating the manual release mechanism for the charging connector on the vehicle is described on the rescue cards.



	Public charging stations may be connected to the public power grid at more than 1,000 volts. If this is the case, the correspondingly larger safety distances must be observed when responding to fires.
	Observe existing regional and national contingency plans and safety instructions for emergency and recovery personnel for public charging stations and wall boxes.
	The charging connections and the appearance of public and private charging stations differ depending on the manufacturer and country.

Charging stations and wall boxes charge with alternating voltage or direct voltage. A system that uses direct voltage (DC) supplies the battery directly via the charging socket.

If alternating voltage (AC) is used to charge the high-voltage battery, the battery charger in the vehicle functions as a voltage converter.



Example positions for manual release from the charging station.

Natural gas drive – safety equipment



The entire natural gas system has been installed in a way that provides the best possible protection from damage and the effects of weather. The gas tanks are highly stable and heat resistant. The high-pressure pipes and connecting elements are made of seamless stainless steel and are routed outside the passenger compartment.

In addition to the electromagnetic shut-off valves, the cylinder valves have an integrated thermal fuse and a flow rate limiter that prevents the uncontrolled escape of gas in the event of possible damage to the pipes or allows the escape of gas in a controlled manner in the event of damage to the valves. A non-return valve is also installed in the first cylinder valve. This prevents gas from flowing back out of the cylinder and into the filler line.



The electromagnetic fuel tank shut-off valves are automatically shut off in the event of an accident in which the restraint systems are triggered.

Fuel tank shut-off valve

Remove the tank covers on the underbody



The tank covers are marked in green in this illustration.

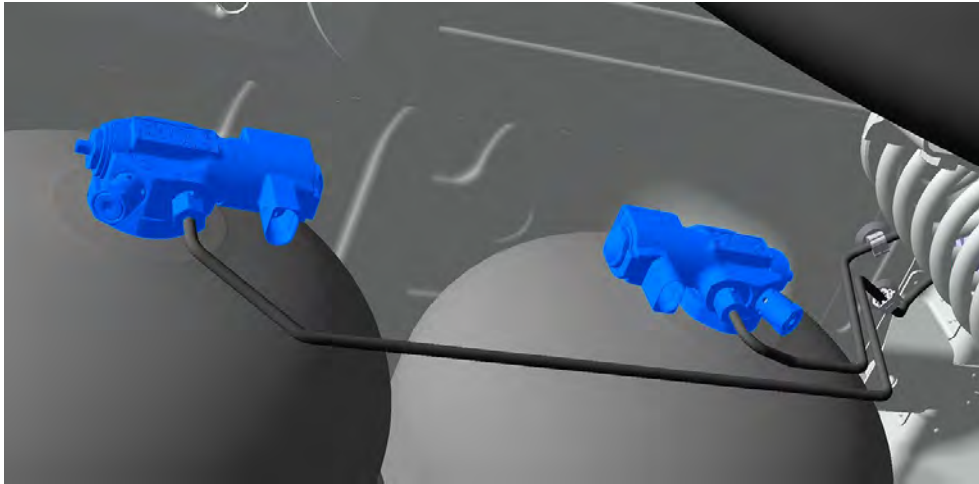

Manually shut off gas tanks



Localise the gas tank shut-off valves



Turn the shut-off valve clockwise as far as it will go using a 5 mm open-end spanner or pliers or a special tool.

	The procedure required for manual shut-off of the gas tanks is described in the Volkswagen rescue cards.
	Labelling of the CNG gas tanks on the rescue cards.
	Labelling of the CNG shut-off valves on the rescue cards.

Liquefied petroleum gas drive – safety equipment



A number of points distinguish vehicles with liquefied petroleum gas drive from conventional vehicles.

Knowledge of these differences is very important for emergency personnel when performing a rescue operation.

A yellow triangular warning sign with a black border and a black exclamation mark in the center.	<p>Liquefied petroleum gas (also designated as LPG or liquefied gas) must not be mistaken for natural gas (also designated as CNG or compressed natural gas). Natural gas and natural gas systems have features that fundamentally distinguish them from liquefied petroleum gas and autogas systems.</p>
--	---

The entire autogas system has been installed in a way that provides the best possible protection from damage and the effects of weather. The gas tanks are highly stable and heat resistant. All high-pressure pipes and connecting elements are made of copper/stainless steel and are routed outside the passenger compartment.

Along with the electromagnetic shut-off valve, the tank has integrated overpressure protection. Furthermore, a non-return valve is installed in the filler stop valve, which prevents the gas from flowing back from the gas tank and into the filler line.

Fuel tank shut-off valve

The fuel tank shut-off valve is an electromagnetic valve and is opened by the gas control unit during LPG operation.

A blue square icon with a white lowercase letter 'i' in the center.	<p>The valve closes automatically when the system is switched over to petrol mode, when the engine is switched off, in the event of an accident involving triggering of an airbag and/or belt tensioner, or if the voltage supply fails.</p>
---	--

Camping gas equipment – safety equipment

The entire camping gas system has been installed in a way that provides the best possible protection from damage and the effects of weather.

The gas lines installed are equipped with a shut-off valve in the vehicle models made by Volkswagen Commercial Vehicles.



Permanently installed shut-off valve for camping gas lines.

Propane or butane gas cylinders are equipped with an additional shut-off valve. The gas cylinders are secured against slippage in the vehicle, and can be removed from the vehicle.



Camping gas cylinders are usually secured against slippage.

Shutting off camping gas cylinders manually

- Locate the shut-off valves for the gas cylinders
- Turn the shut-off valve clockwise as far as it will go



Volkswagen models with camping gas equipment are delivered without gas cylinders.

4. Access to the occupants

4. Access to the occupants

Access to the occupants plays a central role in rescue activities following an accident.

Depending on the accident situation, the emergency and recovery forces have various redundant access options to the occupants.

Unlocking the vehicle doors

Locked doors (exterior door handle non-functional) can be unlocked normally as follows:



- Remote control buttons
- Button in the door trim
- Manual vehicle key / optional Keyless
- Optional via app / Keyless Card



Buttons on the vehicle key's remote control.







Button in the door trim

	Vehicle or equipment-specific information can be found in the vehicle wallet literature or the vehicle-specific rescue cards.
	After an accident with airbag triggering, the vehicle doors and boot lid are automatically unlocked. The doors can be opened by firmly pulling on the exterior door handle.

4. Access to the occupants

Electrically assisted door handles

On some Volkswagen models, operation of the door handles on the inside and outside is electrically assisted. The doors can be conveniently unlocked with very little effort. In the event of a crash, considerably greater force may be required to unlock and open the doors.

	In the event of an accident or failure of the 12-volt vehicle electrical system, significantly greater forces are required to open the doors.
	In the event of an accident in which airbags are triggered, all doors and lids are automatically unlocked.
	After serious accidents, it may also be necessary to use tools.
	When possible, the electric convenience systems should be used for the rescue prior to disconnection of the battery.

Exterior door handles

With electrically assisted door handles, all doors can be unlocked and opened with little effort. To open, reach into the handle recess and fold the door handle up slightly. If the electrical assistance is interrupted or has failed, the door handle must be levered upwards with greater force.

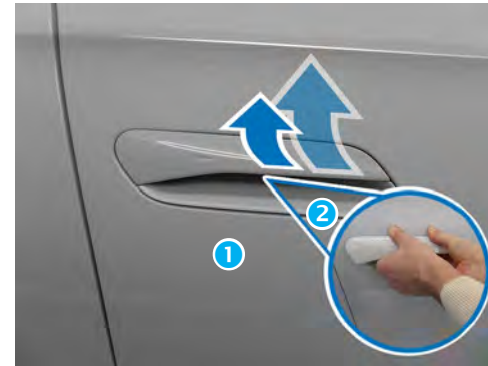

- ② Manual opening: lever door handle far upwards with greater force and open door. The door handle on the ID.7 is shown as an example.
- ① Convenience opening: lift the door handle slightly and open the door.
- ② Manual opening: lever door handle far upwards with greater force and open door.

In special situations, the vehicle can be manually unlocked and opened from the outside as follows using a manual key:

1. Use the vehicle key to prise off the cap in clockwise direction.
2. Insert the key bit into the lock cylinder.
3. To unlock the vehicle, turn the manual key counter-clockwise.
4. To open the door, pull firmly on the driver door handle.

If necessary, the vehicle doors can also be unlocked and opened from the inside by operating the interior door handle.

	When the childproof lock is activated, opening the doors of the 2nd seat row not possible from inside. To open the door from the inside, the childproof lock must first be deactivated mechanically or electrically.
---	--

4. Access to the occupants



Deactivating the childproof lock mechanically with key at the door



Deactivating the childproof lock electrically in the door trim

4. Access to the occupants

Interior door handles

With electrically assisted door handles, the doors can also be conveniently operated from the inside. To do this, fold down the interior door handles slightly and open the doors.

The doors can also be opened by pulling the door handle further if the electrical assistance is interrupted or has failed. Access to the interior door handles is possible:

- via adjacent door
- by opening the window using:
 - remote control buttons
 - buttons in the door trim
- removed window



The door handle on the ID.7 is shown as an example.

- ① Convenience opening: fold down the door handle slightly and open the door.
- ② Manual opening: lever door handle far to the rear with greater force and open door.



After accidents with triggered airbags, the windows move to a crash position (gap of approx. 5 cm). If necessary, the window can be broken out outwards by gripping it inside.



There is a risk of injury when the vehicle windows are broken. Wear appropriate personal protective equipment!



When the anti-play protection is activated, operation of the windows of the 2nd seat row is not possible. To open the windows, the anti-play protection must be deactivated.

4. Access to the occupants

Access via boot lid

Depending on the equipment variant, the boot lid can be unlocked as follows:



Button on the boot lid





Button on the remote control



Button in the door trim on the driver side





The boot lid is opened by pressing the electric button in the boot lid in unlocked state. Some models have an optional electric opening function for the boot lid.

	In the event of an accident in which airbags are triggered, all doors and lids are automatically unlocked.
	If the 12-volt supply is interrupted, it is not possible to open the boot lid in spite of unlocking.
	If necessary, the boot lid can be opened manually from the inside. Please observe the notes in the vehicle-specific Owner's Manual.

Electrically operated sliding doors

Some models of the Volkswagen Commercial Vehicles brand may be equipped with one or more sliding doors that are operated electrically.

Electrically operated sliding doors behave like normal mechanical doors after an accident.

	After an accident or in the event of failure of the 12-volt vehicle electrical system, significantly greater forces are required to open the doors.
	In the event of an accident in which airbags are triggered, all doors and lids are automatically unlocked.
	When the childproof lock is activated, it is not possible to open the doors from inside. To open the door from the inside, the childproof lock must first be deactivated mechanically or electrically.
	When possible, the electric convenience systems should be used for the rescue prior to disconnection of the battery.

Body reinforcements



A high level of safety for the vehicle occupants is achieved in particular by a rigidly designed passenger cell.

The reinforcement of the body is achieved by using high-strength and hot-formed steels with larger wall thicknesses in a multi-shell structure.



Body with reinforced passenger compartment

The reinforced areas are indicated on the model-specific rescue cards. High-performance cutting equipment must be used in these areas when carrying out rescue activities.



	Cutting high-strength or hot-formed steels can result in sharp edges. Wear appropriate personal protective equipment!
	Avoid sensitive components such as airbags, fuel tanks, pipes or high-voltage components. Information about the position of reinforcements can be found on the vehicle-specific rescue cards.
	Labelling of high-strength areas in the rescue cards.

The A-pillar

Convertibles in particular have an additionally reinforced body in order to achieve the necessary rigidity even without a roof. For example, tubular reinforcements are installed in the A-pillar to ensure the protected space in the event of vehicle rollovers together with the protective bar. It may also be possible to open the convertible roof (which is usually a fabric roof) by conventional means or by pushing up the roof with a ram.



A-pillar reinforcement in cabriolets

	<p>Cutting through the A-pillar near the A-pillar reinforcement is only possible using powerful rescue equipment.</p>
	<p>The location of particular reinforcement measures in the individual vehicles can be found on the rescue cards.</p>



The B-pillar

The B-pillar in particular is reinforced using high-strength and hot-formed steels and a multi-shell structure with a large cross-section.

The B-pillar is additionally reinforced around the belt guide, which makes it more difficult to cut through. These areas should therefore be deliberately avoided.



B-pillar with multi-shell structure

	<p>The easiest point to cut through vehicle pillars is the area above the belt height adjuster. The pillar can also be cut through in the lower area. However, note that the cross-section of the pillar is very large and that the belt tensioner is usually located there.</p>
	<p>Always observe the rescue cards.</p>

4. Access to the occupants

The side members

In modern vehicles, high-strength and multi-shell steels are used to reinforce the side members. These increase safety in the event of side collisions.

The electric vehicles in particular feature reinforced side members to protect the high-voltage battery.



Impact protection in the door area

The impact protection in the door area of Volkswagen Group vehicles is made of steel tubes or steel profiles. The tubes or sections are arranged horizontally or diagonally behind the outer door panels.

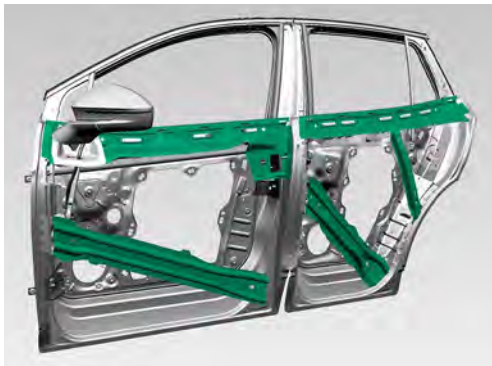
The high-strength sections can be cut through with powerful cutting equipment. The steel tube is installed above the door lock and provides the vehicle with support in the event of a head-on collision, while the steel profiles below the door lock are relevant in the case of a side impact.



Side impact protection in the doors

	The location of particular reinforcement measures in the individual vehicles can be found on the rescue cards.
	Labelling of high-strength areas in the rescue cards.

	A crash tube may be installed in the front doors to better protect the vehicle occupants in the event of a side impact.
---	---

Glazing

The windows in Volkswagen Group vehicles are made of toughened or laminated safety glass.

The windscreen is always made of laminated safety glass (VSG) and the side and rear windows are made of tempered safety glass (ESG) or laminated safety glass, depending on the equipment. At Volkswagen, panoramic glass roofs are always made of tempered safety glass.

Tempered safety glass (ESG)

Tempered safety glass (ESG) is thermally pretreated glass that can withstand high loads. When broken it crumbles into small granular pieces. Tempered safety glass is used for side windows, rear windows, sliding sunroofs and the panoramic glass roof.

	Intact windows can suddenly burst during rescue work at the vehicle. Depending on the accident situation and the scope of emergency work, the windows should be removed first. Windows can be removed by concentrated impact using an automatic punch or an emergency hammer, for example. The windows should first be secured by masking off.
---	--

Laminated safety glass (VSG)

Laminated safety glass consists of two panes of glass with a layer of film in between. The glass remains largely intact when damaged. It is used for windscreens and sometimes for side windows. The windscreens are bonded to the body with adhesive.



	Because laminated safety glass (VSG) windows cannot suddenly burst, they only have to be removed if it is necessary for the rescue work. Laminated safety glass (VSG) windows can be removed using special glass saws or metal cutting claws.
---	---



Tempered safety glass



Laminated safety glass

	Protect the occupants from glass splinters before removing the glass panes.
	Information about the window versions installed is also described in the respective rescue cards for more recent models.





Driver seat and steering wheel adjustment mechanisms

Depending on the situation at the scene of the accident, the emergency and recovery services decide whether it is necessary to adjust the seats or the steering wheel to rescue the occupants.

The seat systems and steering columns in Volkswagen vehicle models may be operated mechanically or electrically.

The head restraints must also be removed if necessary.

To rescue occupants from the second and third row of seats, it may be necessary to move the front seats forward and fold down the backrests or remove individual seats.

	<p>If rescue tools are used in the vehicle interior, ensure that sensitive parts such as the high-voltage battery or pyrotechnical belt tensioners are not damaged.</p>
	<p>In the event of an accident in which airbags are triggered, electrically operated doors and lids are unlocked automatically.</p>
	<p>Depending on the equipment, electrically operated seats may be equipped with a convenient entry version. This function automatically moves the seat to various positions.</p>
	<p>When possible, the electric convenience systems should be used for the rescue prior to disconnection of the battery.</p>

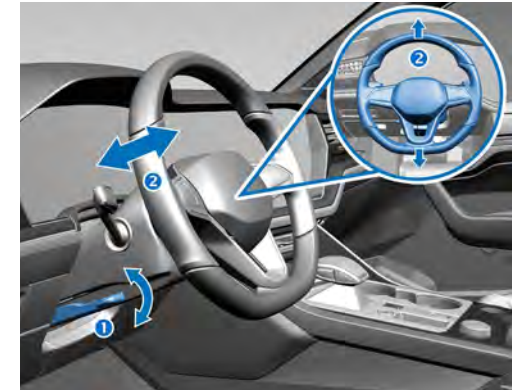

Mechanical steering column adjustment

- ① Unlock the steering column
- ② Adjust the steering column



Electric steering column adjustment

- ① Unlock the steering column
- ② Adjust the steering column

Electric seat adjustment

- ① Adjust lumbar support
- ② Adjust seat frame
- ③ Adjust backrest frame



Electric convenience systems

Depending on the model series and vehicle equipment, Volkswagen AG vehicles feature a range of electrically operated convenience systems, for example:

- Electric doors
- Electric windows
- Electric sliding sunroof
- Electric CSC roof
- Electric seat adjustment
- Electric steering column adjustment
- Electric unlocking, opening and closing of the luggage compartment



If the vehicle electrical system battery or batteries is/are disconnected, these systems can no longer be operated.















The battery should only be reconnected to the vehicle electrical system by workshop personnel.

5. Stored energy / liquids / gases / solids

Volkswagen models carry a wide range of service fluids. Only if you recognise a hazard during an emergency can you react appropriately and take suitable action to prevent it.

	<p>With all energy carried or stored (pyrotechnical belt tensioners, airbags, gas struts, fuels, gases, etc.) there is a risk of expansive discharge after an accident.</p>
	<p>Always wear appropriate protective equipment when handling leaking operating fluids.</p>

Mainly carried service fluids

- | | |
|--|--|
|  Brake fluid |  Anti-freeze protection |
|  Grease |  Fuel |
|  Gear oil |  Steering gear oil |
|  Hydraulic fluid |  Engine oil |
|  Refrigerant |  NO _x reducing agent |
|  Air conditioner compressor oil |  Washer fluid concentrate |
|  Anti-corrosion oil | |

Warning labels for high-voltage components

This is why extensive warning labelling comprises a part of the safety concept of high-voltage vehicles, for example.



Example of a high-voltage battery for the ID.3

All high-voltage components are labelled with clear warning stickers. An exception to this are the high-voltage cables, which are immediately recognisable by the orange warning colour of their sheathing.

Three types of warning sticker are always used:

- Yellow stickers with a warning symbol for electrical voltage
- Stickers with the word "Danger" on a red background
- Stickers with a special warning for people with pacemakers.

The yellow stickers refer to the high-voltage components that are installed near the sticker or concealed under covers.

The warning stickers with the "Danger" lettering indicate the high-voltage components directly.

Examples of warning stickers in high-voltage vehicles:





The high-voltage vehicle electrical system

Classification as a high-voltage component or high-voltage vehicle electrical system depends on the voltage type "AC" or "DC".

Alternating voltages (AC) above a supply voltage of 30 volts and direct voltages (DC) above a supply voltage of 60 volts are generally referred to as high-voltage components or as a high-voltage vehicle electrical system.

Definition of terms used in vehicle construction (example Volkswagen)

- Low voltage: of up to 60 volts (usually 12 volts and 48 volts in passenger vehicles and 24 volts for trucks/commercial vehicles)
- High voltage: from 60 volts to approx. 1,000 volts

	<p>Even though the terms are based on the voltage, the actual danger from direct contact with electrical energy is the strength of the current that flows through the human body in a closed circuit. This means that, even at low voltage, contact with electrical energy can present a danger to life when the current rating is correspondingly high.</p>
	<p>Do not touch, cut or open high-voltage components and high-voltage batteries! Wear appropriate personal protective equipment!</p>
	<p>Only a few electrical components in high-voltage vehicles are operated using high voltage (e.g. high-voltage battery, high-voltage cables, power and control electronics for electric drive, electric drive motor/alternator, air conditioner compressor, external charging socket). All other electrical components, such as lighting, vehicle electronics etc. are supplied with power by the 12-volt vehicle electrical system voltage (passenger vehicle) or 24-volt vehicle electrical system voltage (truck).</p>

High-voltage batteries are rechargeable batteries. Various types of battery are used, depending on the manufacturer and the vehicle. They differ in the chemical components used in the battery cells for the anode, cathode and electrolyte, as well as in the shape of the battery cell (round, prismatic, pouch).

Lithium-ion batteries (Li-ion) are currently used, for example.

The sizes and fitting locations of the high-voltage batteries differ depending on the type of vehicle. A fully electric vehicle requires a larger high-voltage battery than a hybrid vehicle.

The following battery concepts and fitting locations of high-voltage batteries are currently in use:

- Below almost the entire underbody
- Below the underbody in front of the rear axle
- Between the axles

A high-voltage battery consists of many battery modules, which in turn consist of the battery cells themselves.

All high-voltage batteries are structurally protected in order to reduce the risk of electrolyte escaping from damaged battery cells to a minimum, for example after an accident.

In the event of an accident, the high-voltage battery is protected from mechanical influences by a battery housing. This directs most of the impact energy into the vehicle structure.

	<p>In addition to the high-voltage battery, Volkswagen electric vehicles also have at least one 12-V electrical system battery.</p>
---	---

Battery concepts

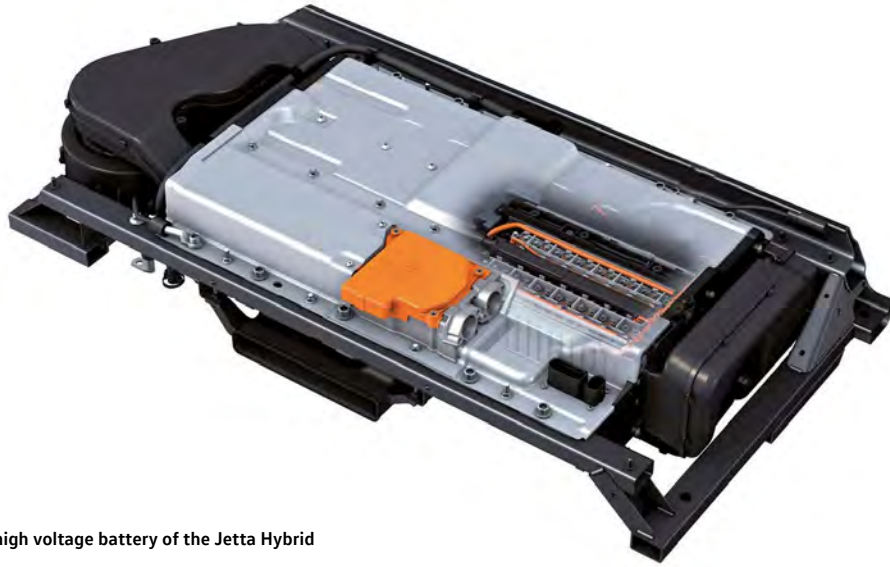

The high voltage battery of the Jetta Hybrid

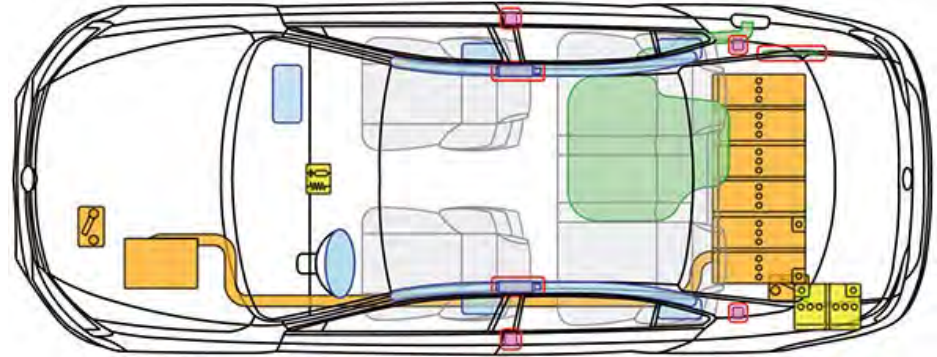

Fitting location of the high-voltage battery in the Jetta Hybrid.
(The illustration does not correspond to the current ISO 17840.)



The high-voltage battery of the Passat GTE

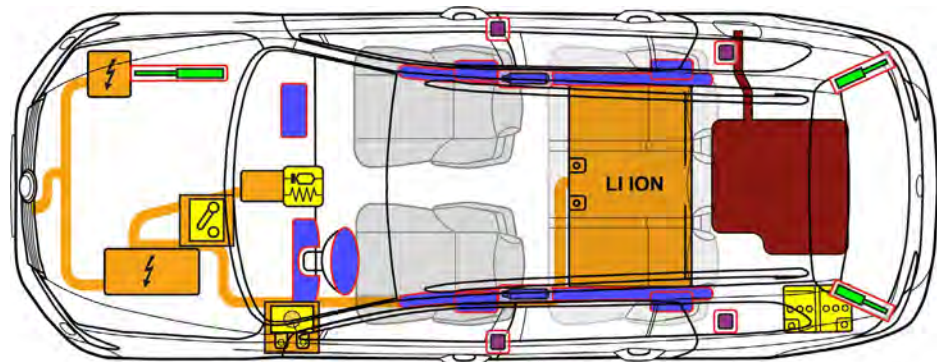

Fitting location of the high-voltage battery in the Passat GTE.

Battery concepts

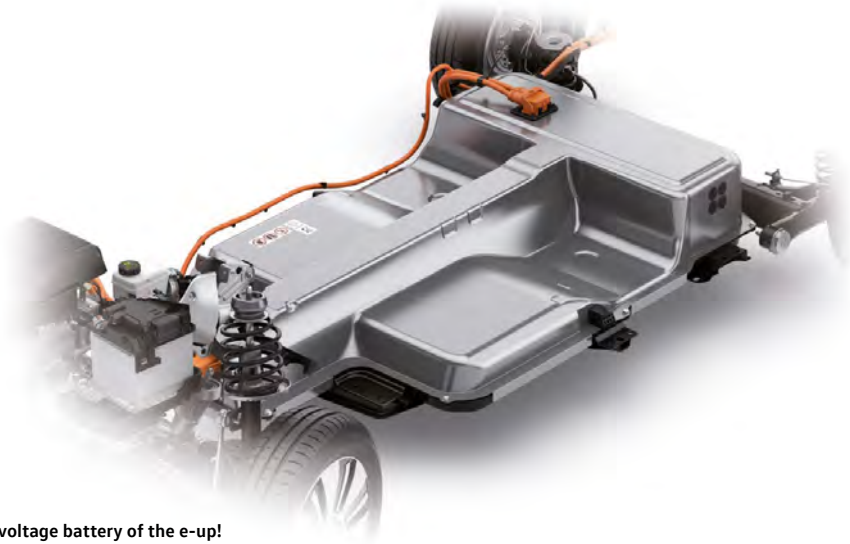

The high-voltage battery of the e-up!

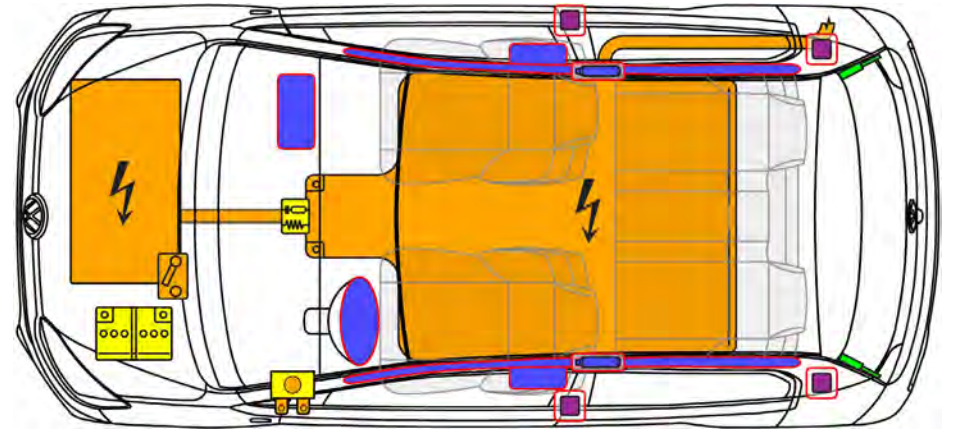

Fitting location of the high-voltage battery in the e-up!

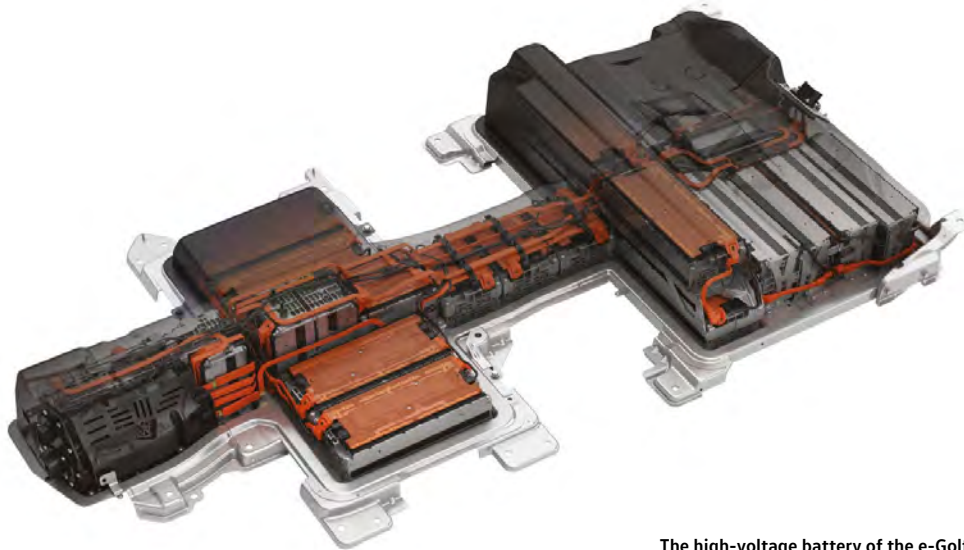

The high-voltage battery of the e-Golf

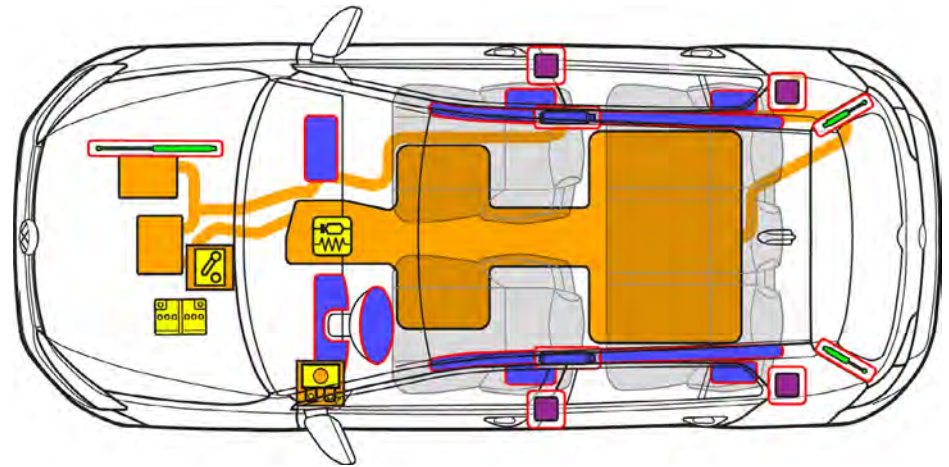

Fitting location of the high-voltage battery in the e- Golf.

Battery concepts

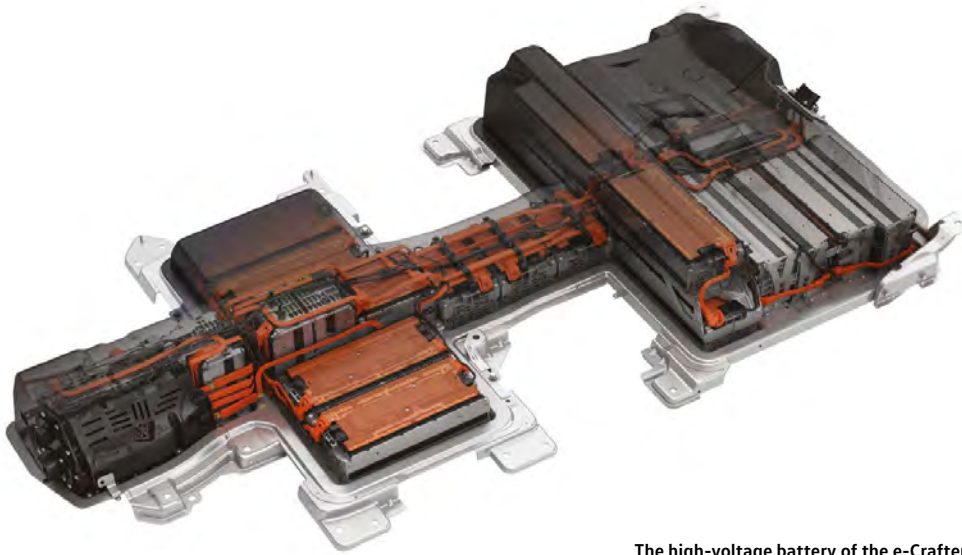

The high-voltage battery of the e-Crafter

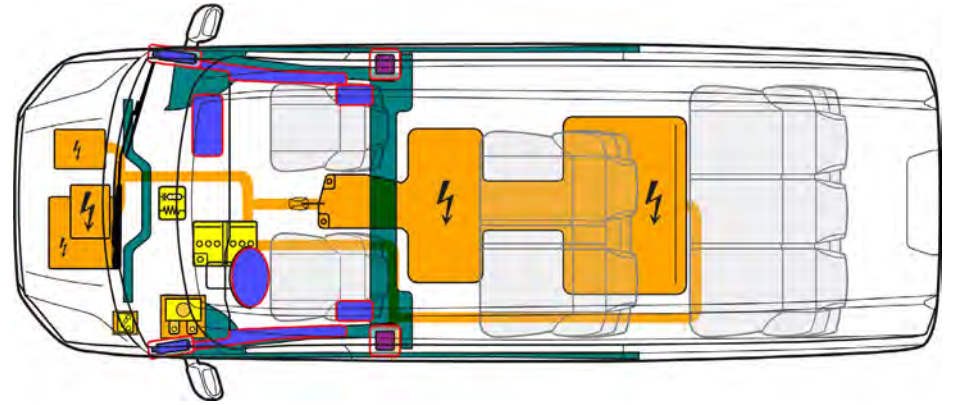

Fitting location of the high-voltage battery in the e-Crafter



The high-voltage battery of ID. family

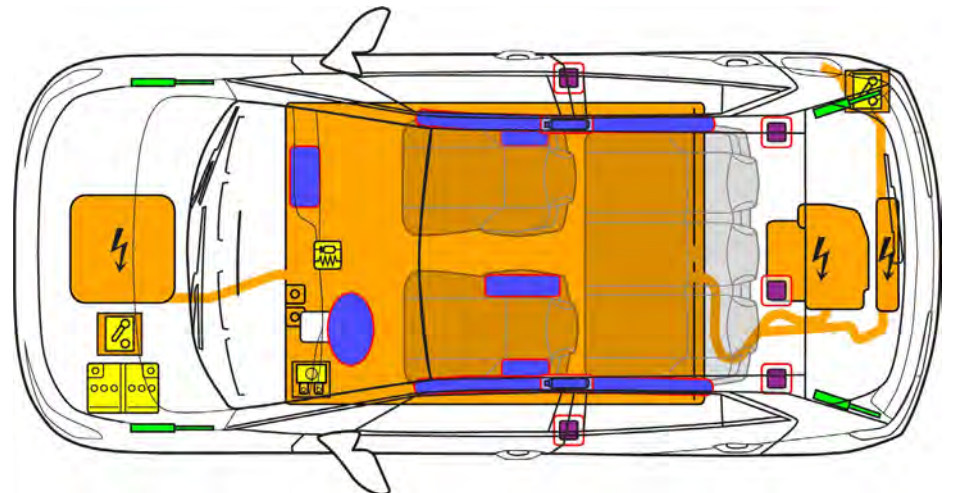

Fitting location of the high-voltage battery in the ID.3



Air conditioning system

The refrigerants R134 a, R1234 yf and R744 (CO₂) are used for the air conditioning systems. More detailed information on the different refrigerants can be found on the following web page:

www.dguv.de/ifa/gestis/gestis-stoffdatenbank/index.jsp





High-voltage battery – cooling system

In normal operating conditions, there is no danger of exposure to the contents of the battery.

	If refrigerant escapes from the battery cooling system, there is a risk of a thermal reaction in the high-voltage battery. Monitor the temperature of the high voltage battery!
	In the event of outgassing of the high voltage battery, toxic vapours may form. Wear appropriate personal protective equipment!
	Vehicle-specific information is also described in the respective rescue cards.



12-volt electrical system battery

12-volt vehicle batteries in lead-acid technology are primarily used in the Volkswagen Passenger Cars and Volkswagen Commercial Vehicles models. The 12-volt lead batteries differ in terms of a leak-proof technology (completely black box and "AGM" lettering on the label) and a technology that is not leak-proof in the event of damage to the housing (identifiable by the black cover and transparent box). Both technologies use "sulphuric acid" as the electrolyte.

 	There may be a highly explosive gas mixture in the battery. No flames, sparks, open light and smoking near the battery! Wear appropriate personal protective equipment! "Explosive" sticker on the battery
	Escaping electrolyte can cause severe burns to skin.
	Vehicle-specific information is also described in the respective rescue cards.





Batteries with a solid electrolyte

The absorbent glass mat batteries, also known as AGM batteries or recombination batteries, are used in vehicles with a start/stop system and energy recovery. Glass mat batteries are batteries in which the sulphuric acid is sealed in an absorbent glass mat (AGM). This battery type can be identified by the AGM lettering on the battery cover and the completely black battery housing.

	Escaping electrolyte can cause severe burns to skin.
	Vehicle-specific information is also described in the respective rescue cards.

Lithium-ion battery (12 and 48 volts)

Lithium-ion batteries with a voltage of 12 or 48 volts are installed in a number of Volkswagen models (e.g. mild hybrid models with belt-driven starter-alternator).

	Lithium-ion batteries can self-ignite or re-ignite after fire-fighting measures! Wear appropriate personal protective equipment!
	Escaping electrolyte can cause severe burns to skin.
	In the event of outgassing of the lithium-ion battery, toxic vapours may form. Wear appropriate personal protective equipment!
	Vehicle-specific information is also described in the respective rescue cards.

Further information is available from the Battery Association of the Zentralverband Elektrotechnik- und Elektronikindustrie e. V. (German Central Electrical Engineering and Electronics Industry Association). www.zvei.org/verband/fachverbaende/batterien

Compressed air tanks



Some Volkswagen models have accumulators for air suspension or air conditioning systems, for example. Do not damage these accumulators and never open them by force.

Flammable materials

Examples of these include:

- Plastics
- Electrolytes
- Resins
- Magnesium
- Gases or other flammable liquids

Resins are used for bonding carbon fibres, magnesium components are found in the engine compartment.

	<p>Avoid skin contact and inhaling electrolyte vapours, as electrolyte is combustible, corrosive and irritating. Please wear appropriate personal protective equipment!</p>
	<p>Contaminated extinguishing water must be dealt with according to the national procedures for emergency and recovery personnel.</p>



Physical properties of natural gas

Dealing with natural gas vehicles is different to dealing with conventional vehicles. However, any dangers can be controlled appropriately and to the same extent if the special points to note are known.

The gas tanks in current Volkswagen models can be made of steel or of carbon fibres.

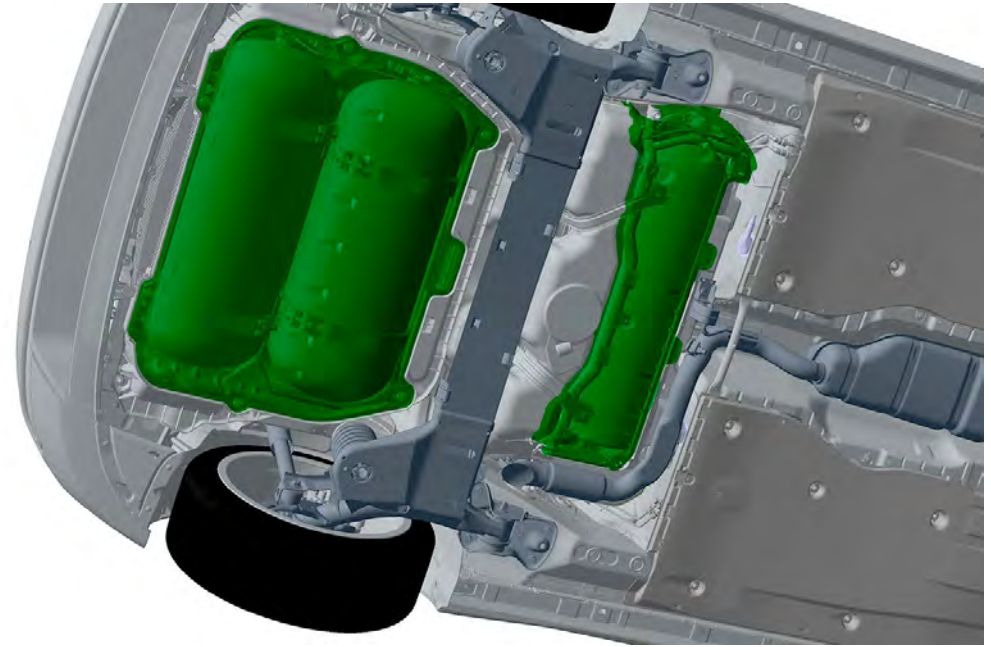
- Natural gas is mixed with an odourant, for example, for use in a vehicle. This allows any escape of natural gas to be determined before the lower explosion limit is reached.
- Natural gas is lighter than air (density ratio natural gas/air approx. 0.6) and therefore dissipates quickly outdoors!
- Explosion range between 4% by volume and 17% by volume
- Ignition temperature approx. 640°C



	<p>Labelling of vehicles with CNG drive.</p>
	<p>Avoid skin contact and inhalation of broken carbon fibres.</p>

Physical properties of liquefied petroleum gas (also referred to as liquefied gas or LPG)

A number of points distinguish vehicles with liquefied petroleum gas drive from conventional vehicles.

Knowledge of these differences is very important for emergency personnel when performing a rescue operation.

- An odorant with an intensive smell is added to liquefied petroleum gas for use in vehicles.
- Gaseous, liquefied petroleum gas is heavier than air (density ratio of LPG/air approx. 1.55) and accumulates in depressions and open shafts (e.g. waste water shafts and channels).
- Liquefied petroleum gas is liquefied at a pressure of 8 bar, whereby its volume decreases considerably (1/260th of its original volume).
- Explosion range between 1.4 and 10.9% by volume
- Ignition temperature approx. 460 °C



Liquefied petroleum gas (also designated as LPG or liquefied gas) must not be mistaken for natural gas (also designated as CNG or compressed natural gas). Natural gas and natural gas systems have features that fundamentally distinguish them from liquefied petroleum gas and autogas systems.

Safety equipment

The entire autogas system has been installed in a way that provides the best possible protection from damage. The gas tanks are highly stable and heat resistant. All high-pressure pipes and connecting elements are made of copper/stainless steel and most of them are routed outside the passenger compartment.

Along with the electromagnetic shut-off valve, the tank has integrated overpressure protection. Furthermore, a non-return valve is installed in the filler stop valve, which prevents the gas from flowing back from the gas tank and into the filler line.

Fuel tank shut-off valve

The fuel tank shut-off valve is an electromagnetic valve and is opened by the gas control unit during LPG operation.





The valve closes automatically when the system is switched over to petrol mode, when the engine is switched off, in the event of an accident involving triggering of an airbag and/or belt tensioner, or if the voltage supply fails.

Physical properties of camping gas

Dealing with vehicles with camping gas equipment is different to dealing with conventional vehicles. However, any dangers can, so to speak, be appropriately brought under control when knowledge of their special features is available.

Camping gas cylinders are accessories and are normally not included in the equipment that comes with vehicles.

Camping gas (propane or butane gas) exhibits similar properties to liquefied petroleum gas (LPG), is heavier than air and accumulates in depressions and shafts.

	Labelling of vehicles with camping gas equipment.
	Camping gas cylinders (propane or butane) are generally secured to stop them moving in the vehicle.

6. In case of fire

General information on vehicle fires

In principle, all country-specific regulations, work instructions and guidelines issued by the respective fire-fighter associations and public authorities on how to proceed in the event of a vehicle fire must be observed. When possible, the fire must be prevented from spreading to the energy storage unit (fuel, gas, battery).

All the usual and familiar extinguishing agents such as water, foam, CO₂ or powder can be used.

Which extinguishing agent is to be used with which extinguishing method can only be decided at the deployment site, and is highly dependent on the actual situation and the equipment available.



If the airbags did not deploy during the accident, they may deploy in the event of a vehicle fire.

Fire in high-voltage vehicles

Dealing with high-voltage vehicles is usually no more dangerous than dealing with petrol or diesel vehicles, however a number of points do differ. Knowledge of these differences can be important for the rescue operations in the event of accidents involving passenger vehicles.

The following distinction must be made in the event of a vehicle fire with high-voltage vehicles:

- Vehicle fire without an energy storage unit with a flammable electrolyte catching fire:**
 As is the case for a passenger vehicle with a conventional drive, all conventional and familiar extinguishing agents such as water, foam, CO₂ or powder can be used in case of a "normal" fire in a hybrid or electric vehicle (HEV or BEV, without the high-voltage battery catching fire) depending on requirements and/or availability.
- Vehicle fire with an energy storage unit with a flammable electrolyte catching fire:**
 Smoke, flying sparks, darting flames from the battery may indicate that the lithium-ion battery is involved in the fire.
 When a high-voltage battery catches fire, it should be extinguished with water whenever possible and then be cooled.
 In this case, it must be ensured that sufficient water is used and, when possible, the extinguishing water enters the high-voltage battery through the openings caused by the fire or collision.
 The jet of water should be aimed as directly as possible at the battery.
 The installation position of the high-voltage battery can be found in the rescue card for the respective model.

The decision about which measures are suitable is made at the deployment site by the fire brigade, and is highly dependent on the actual situation (e.g. progress of the fire and time at which the fire brigade arrives) and the equipment available.

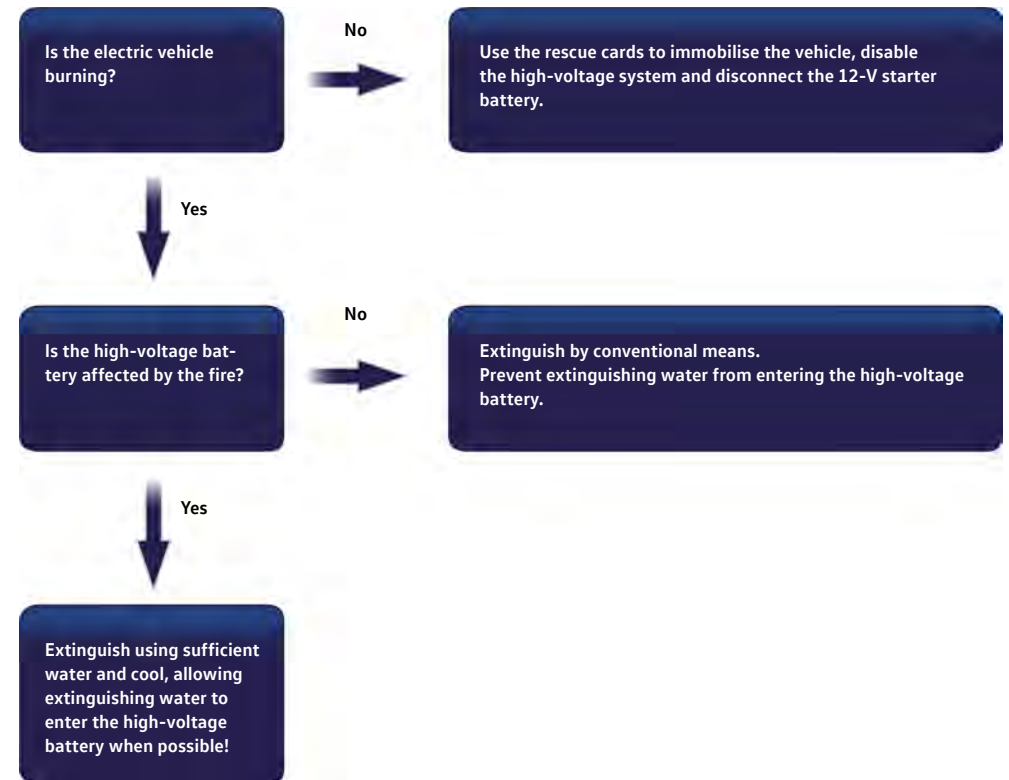

Flow chart for fires in electric vehicles.

If severe damage occurs (e.g. a dented, broken or cracked housing), a lithium-ion battery may react to the effect of water or effect of the fire immediately or only after a delay. This is why signs of a reaction (e.g. smoke, heat, noises, sparks etc.) must be observed during activities on a vehicle with a lithium-ion battery which has been in an accident.

In the event of a reaction by the lithium-ion battery, protective measures and countermeasures must be initiated.
 Smoke hazardous to the human health is produced from fires in electric or hybrid vehicles, just as it is in vehicles with a conventional drive. This is why the corresponding personal protective equipment is recommended.





6. In case of fire



In the event of a fire, outgassing of the high-voltage battery should be expected, as the battery features mechanical safety mechanisms that open, for example in the event of an increase in temperature or pressure due to a fire, and therefore result in deliberate "outgassing" and pressure release.

Extinguishing a vehicle with a high-voltage battery and extinguishing a burning high-voltage battery is possible. According to the VDA guide on rescue and recovery in accidents, water is the most suitable extinguishing agent and there is no fundamental difference from fighting a fire in a conventionally powered vehicle.

If the high-voltage battery is involved in a fire, large quantities of water are required to cool or extinguish an undamaged high-voltage battery that is reacting.

Following a reaction, the lithium-ion battery must be cooled with water until it has reached a temperature approximately equivalent to ambient temperature. The use of a thermal imaging camera or an IR thermometer is recommended.

	After putting out the fire, there may still be dangerous voltages.
	When batteries are not completely burnt out, they may ignite again. Extinguished vehicles must be moved to a safe position; the vehicle may have to be watched.
	A sufficient safety distance must be maintained. The corresponding self-contained respiratory protection equipment must be worn!
	Evaporations and gases can be suppressed by spraying jets of water.

	Defective cells may burst, causing an exothermic reaction.
	A fire may break out some time after the accident, as there may be a residual risk of delayed fire. This is particularly the case if the high-voltage energy storage units are damaged (see also chapter 8. Towing / transportation / storage). An electrical hazard may also persist. High-voltage components must not be touched and suitable personal protective equipment must be worn. High-voltage cables may have been damaged by the heat.
	Further information can be found in the respective rescue cards.



Fire in natural gas vehicles



Dealing with natural gas vehicles usually is no more dangerous than dealing with petrol or diesel vehicles; however there are also a number of special features in this case that must be observed during rescue operations in the event of accidents involving passenger vehicles.

In the event of a vehicle fire in which the natural gas fuel tanks are also exposed to heat, the thermal fuses will react at a temperature of approx. 110°C and a defined discharge of the natural gas occurs, which ignites and burns off. When the natural gas fuel tank is full, blowing off the natural gas takes approx. 90 seconds until it is completely empty.

Vehicles may be equipped with one or more gas tanks. The time at which a specific tank blows off/burns off cannot be determined precisely.

As soon as no more natural gas is being blown off, conventional fire fighting can begin. If the natural gas tanks are not affected by the fire (e.g. in the event of a fire in the engine compartment), fire fighting can also be initiated straight away.





	<p>A sufficient safety distance must be maintained. Corresponding personal protective equipment must be worn!</p>
	<p>Further information can be found in the respective rescue cards.</p>



	<p>When the overpressure protection reacts, gas escapes from the valve. If the vehicle is standing on its wheels, the flow of gas is directed downwards towards the ground. If the vehicle is lying on its side or on its roof, a darting flame may emerge to the side or upwards. Maintain the safety distance from the vehicle. Approach it from the front whenever possible.</p>
	<p>Personal protective equipment must be worn, including self-contained breathing apparatus!</p>
	<p>If the airbags did not deploy during the accident, they may deploy in the event of a vehicle fire.</p>

Fire in LPG vehicles

In the event of a vehicle fire in which the liquefied petroleum gas tank is also exposed to heat, the overpressure protection responds at a pressure of 27.5 bar and a pulsating discharge of the liquefied petroleum gas occurs, which ignites and burns off.

If the liquefied petroleum gas tanks are not affected by the fire (e.g. in the event of a fire in the engine compartment), conventional fire fighting can also be initiated straight away.

	<p>If the vehicle is lying on its side or on its roof, a darting flame may emerge when the overpressure protection responds. If the vehicle is standing on its wheels, the flow of gas is directed out below the gas tank, vertically to the ground. Maintain the safety distance from the vehicle. Approach it from the front whenever possible.</p>
	<p>If possible, take cover when cooling the gas tank to prevent heating up before the overpressure protection responds. Continue cooling the tank even when the overpressure protection responds.</p>
	<p>Personal protective equipment must be worn, including self-contained breathing apparatus!</p>
	<p>If the airbags did not deploy during the accident, they may deploy in the event of a vehicle fire.</p>

	<p>A sufficient safety distance must be maintained.</p>
	<p>The loud discharge noise (hissing) indicates that overpressure protection has responded!</p>
	<p>Further information can be found in the respective rescue cards.</p>

7. In case of submersion

Vehicle under water



A vehicle that is immersed in water must be dealt with in the same way as a damaged vehicle that has been in an accident.

The safety and security regulations must be observed, and the procedure to eliminate immediate dangers must be followed, see chapter [3. Disable direct hazards / safety regulations](#).

High-voltage vehicle under water

- When it is in the water, the high-voltage system does not present an increased risk of electric shock.
- The same instructions apply as in chapter [3. Disable direct hazards / safety regulations](#).
- The recovery procedure is the same as for conventional vehicles. This also applies to bodies made of carbon fibre reinforced polymers.

Source: Verband der Automobilindustrie (VDA) (German Association of the Automotive Industry), Unfallhilfe & Bergen bei Fahrzeugen mit Hochvolt-Systemen (Accident assistance and recovery of vehicles with high voltage systems), FAQ.

	<p>In the event that water enters the high-voltage battery, electrolysis may be triggered and cause a deflagration of oxyhydrogen gas.</p>
	<p>The high-voltage system must be deactivated (see chapter 3. Disable direct hazards / safety regulations). Wear appropriate personal protective equipment!</p>
	<p>In the case of heavily soaked vehicles, it is recommended to de-energise the Disconnecting the 12-volt vehicle battery or Disconnecting the 48-volt battery due to the danger of electrolysis.</p>

Natural gas vehicle under water

- The same instructions apply as described in chapter [3. Disable direct hazards / safety regulations](#).
- The recovery procedure is the same as for conventional vehicles.

After recovering the vehicle, allow the water to drain.



If gas escapes, close the shut-off valves of the tanks (see chapter [3. Disable direct hazards / safety regulations](#)).

8. Towing / transportation / storage

Recovering vehicles involved in accidents

When loading, transporting and storing, the instructions in the rescue cards must be observed.



Example illustration (front towing eye)



Example illustration (rear towing eye)



The rescue and emergency services on site decide on the respective procedure.

Recovering high-voltage vehicles involved in accidents from a danger area

Vehicles with high-voltage batteries should, in principle, be transported away on flatbed vehicles.



The high-voltage system must be disabled prior to transport, see section 3 "Disable direct hazards / safety regulations".

Before transporting the vehicle away (e.g. by a towing company), the condition of the lithium-ion battery should be checked again. The vehicle may only be loaded and transported away if the vehicle does not show any signs of a reaction near the lithium-ion high-voltage battery for an extended period, see the flow chart on the next page.

If vehicles that have been in accidents have a damaged battery or the battery exhibits anomalies, wait until the reaction of the lithium-ion battery has abated before loading, so that no further reaction need be expected on the transport route, see the flow chart on the next page. The shortest and safest route possible must be selected. Travelling through tunnels should be avoided.

If there is any need or doubt, it may be necessary to have the breakdown truck accompanied by a fire engine.

Vehicles with a damaged high-voltage battery should be transported to a safe storage location.





After transport, electric or hybrid vehicles that have been in accidents should not be parked in enclosed buildings, but outdoors at a sufficient distance from other vehicles, buildings and combustible objects or surfaces.

Preference should be given to using designated "quarantine areas" at the storage location. The vehicle that was involved in the accident must be parked outdoors in a suitable location due to the potential which exists, in theory, for the lithium-ion battery to still react. The parking space must be marked accordingly (signs/fencing). A minimum distance of five metres must be maintained to other vehicles, buildings or flammable objects. The distance can be reduced by taking appropriate measures, e.g. fire barriers etc.

The persons responsible at the towing company, the workshops and, if relevant, the scrapyard must be made aware of the special features of and risks presented by the vehicle.

	<p>Lithium-ion batteries can self-ignite or re-ignite after fire-fighting measures!</p>
	<p>In the event that vehicles that have been in accidents have a damaged high-voltage battery or the battery exhibits anomalies: deactivate the high voltage system (see chapter 3. Disable direct hazards / safety regulations). Park the vehicle at a safe distance of at least five metres from buildings and other vehicles (quarantine area).</p>
	<p>When loading the vehicle, take care not to damage the high-voltage components. If possible, lift the vehicle at the indicated lifting points.</p>
	<p>Vibrations during transport may cause high-voltage batteries to self-ignite again.</p>

8. Towing / transportation / storage

	<p>Recommendations for specific vehicles can be found on their rescue cards.</p>
	<p>Whenever possible, monitor any changes in temperature using corresponding devices, e.g. IR camera, for an extended period.</p>
	<p>A large metal container, e.g. container, is recommended for transporting away a high-voltage energy storage unit or parts thereof that have been disconnected from the vehicle. The condition of the high-voltage energy storage unit must be observed (e.g. development of smoke, noises, sparks, development of heat) and flooding of the metal container must be prepared.</p>
	<p>Further information can be found in chapter 5. Stored energy / liquids / gases / solids (lithium-ion battery disconnected from the vehicle).</p>

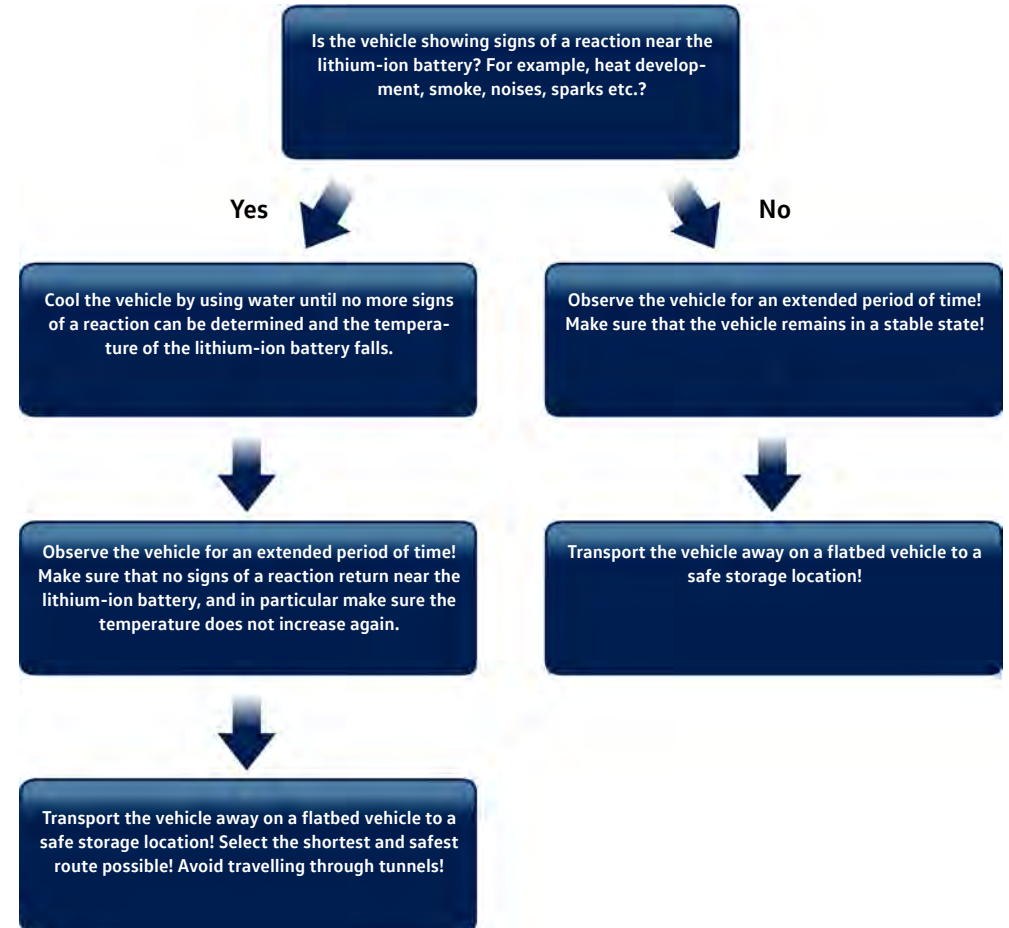





Flow chart for towing electric vehicles.

Recovery of natural gas vehicles involved in accidents from a danger area.

When loading, transporting and storing, the instructions in the rescue cards must be observed.

The natural gas tanks must be manually shut off before transport, see chapter 3. [Disable direct hazards / safety regulations](#).

	Do not tow away a vehicle that was in an accident by the drive axles.
	When towing and parking the vehicle, make sure that the gas tanks are not damaged.
	If gas escapes, shut off the shut-off valves for the tanks manually (see chapter 3. Disable direct hazards / safety regulations).
	Recommendations for specific vehicles can be found on their rescue cards.

9. Important additional information

Modern vehicles have extensive occupant protection systems which can vary according to the vehicle type and specification package.

Airbag

A current vehicle with maximum equipment includes the following main components:

- Airbags
- Airbag control unit
- Sensors
- Belt tensioners
- Components that release the rollover bar in convertibles

Preloaded springs or pyrotechnics are used to trigger it. The job of the electronics integrated in the airbag control unit is to detect vehicle deceleration and acceleration and decide whether to deploy protection systems.

In addition to the sensors in the airbag control unit, sensors e.g. in the front doors are also used to detect vehicle deceleration and acceleration during an accident. Only once they have evaluated the information from all sensors do the electronics in the airbag control unit decide whether and when to activate the safety components. Depending on the nature and severity of the accident, they may only deploy the belt tensioners or the tensioners together with the airbags, for example.

The control unit is indicated as follows on the rescue cards:

	Identification of airbag control unit on the rescue card
---	--

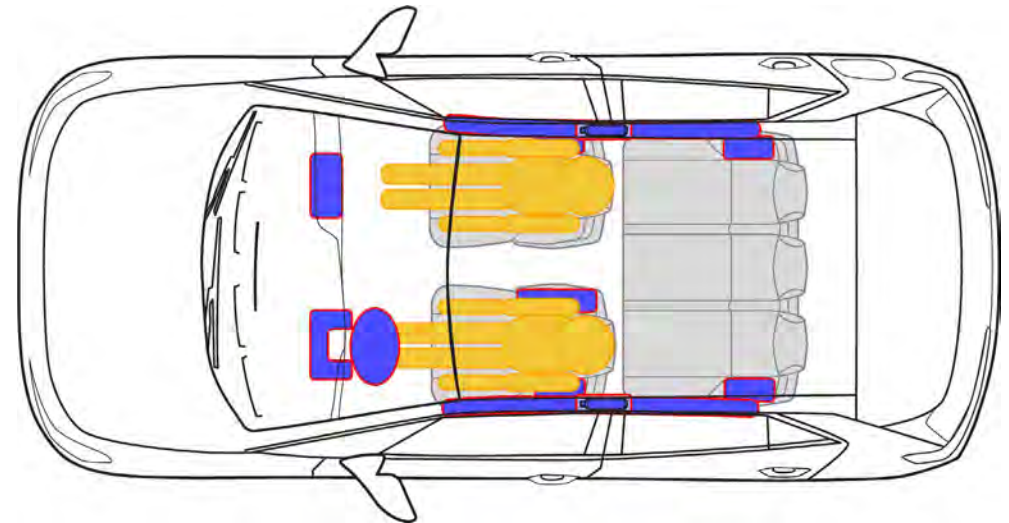

Airbags in today's vehicle models.

Only those safety systems which afford protection in the specific accident situation are triggered.

In addition to the main function for controlling the airbags, the airbag control unit may also have the following functions:

- Emergency release of the central locking
- Switching on the interior lights
- Switching off the fuel pump
- Switching on the hazard warning lights
- Transmission of a signal to send the eCall
- Opening the windows after an accident
- Switching off the air conditioning

Gas generators produce the quantity of gas required for inflating the airbags, filling the airbags within milliseconds. The inflated airbags protect vehicle occupants who are wearing seatbelts from striking the inner body contours (e.g. the steering wheel, dash panel etc.) in the event of a severe accident.

Depending on the installation location and requirements, stored gas inflators of various designs or modes of action are used.

9. Important additional information

The safety systems are triggered depending on the type of accident or direction of impact

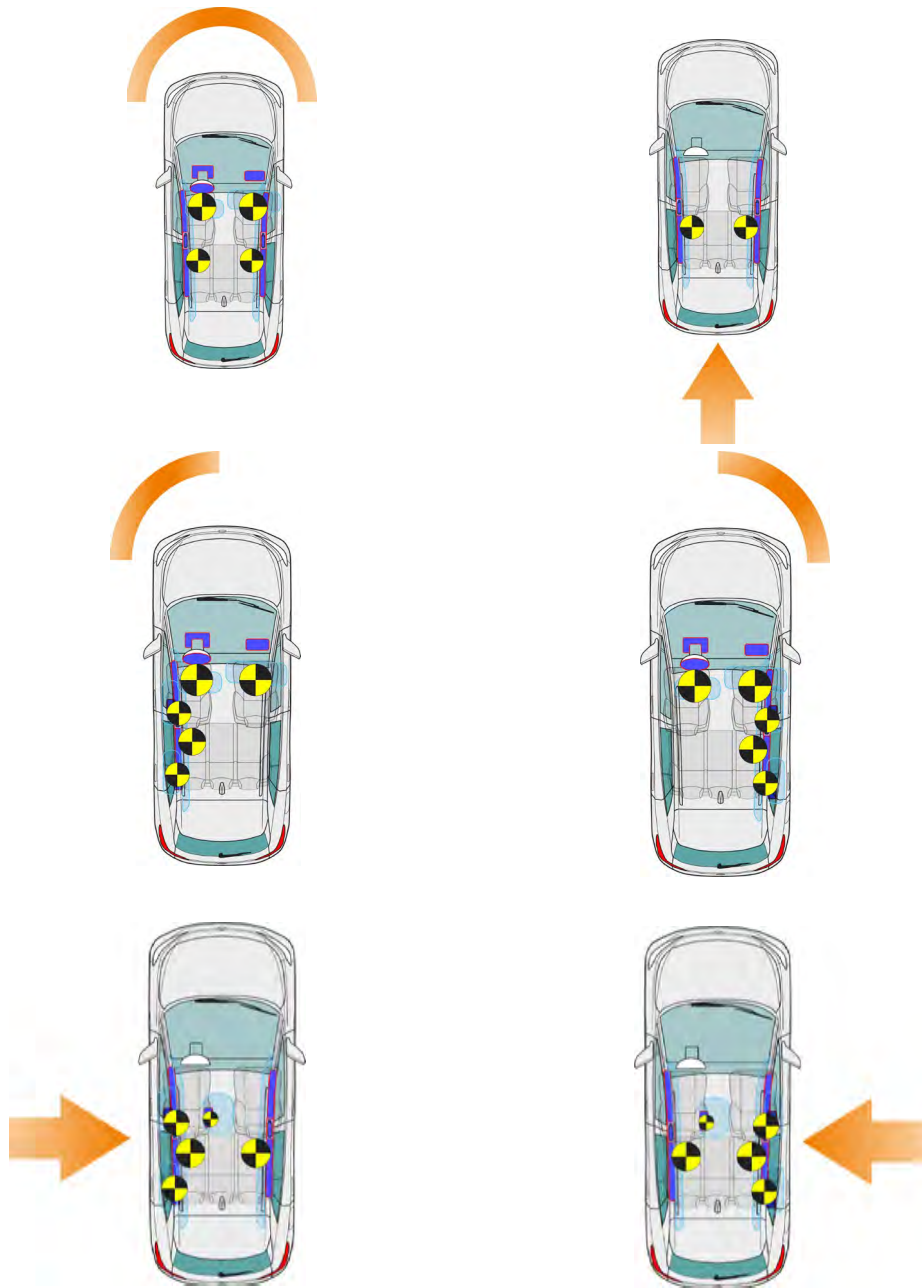

The safety systems are triggered depending on the type of accident or direction of impact (ms = milliseconds).

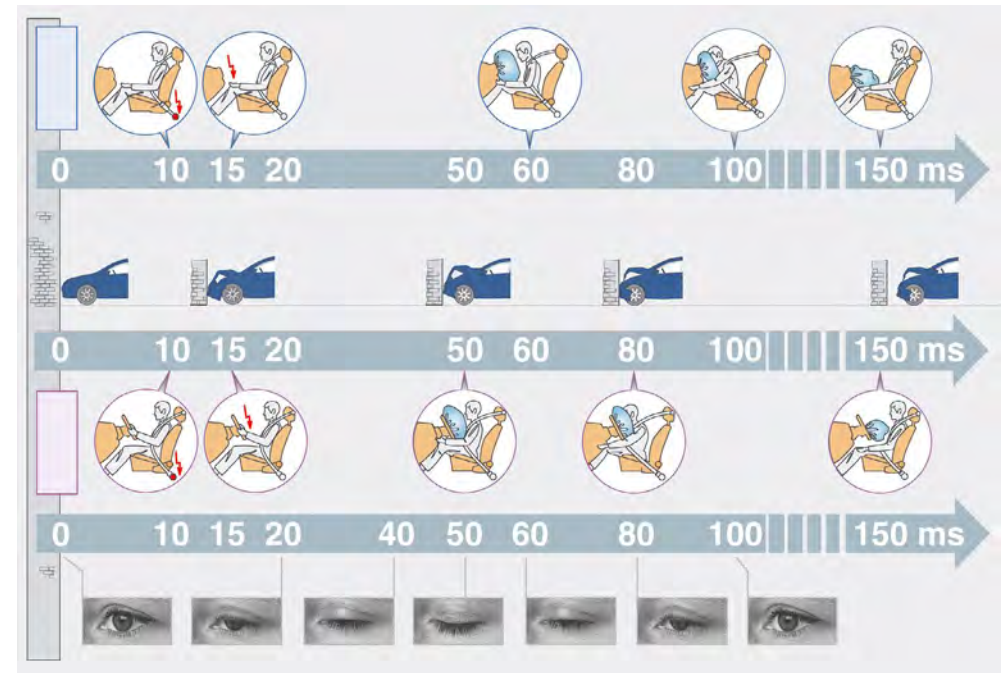

Airbags are indicated in the rescue cards as symbols or outlines as follows:

	<p>Driver airbag, front passenger airbag, side or centre airbag, knee airbag and curtain airbag</p>
--	---

Front airbag

Driver airbag

The driver airbag unit essentially consists of a cap, the airbag and a stored gas inflator. It is fitted in the steering wheel and electrically connected to the airbag control unit via a contact unit.

The airbag is folded up under the cap and its shape and size are designed so that it inflates as protection between the driver and steering wheel.

The driver airbag is inflated by a stored gas inflator. The unfolding airbag breaks the cap on the steering wheel along a special seam and is instantly filled with gas. The entire process from ignition of the stored gas inflator to the fully inflated airbag only takes a few milliseconds.

Vents on the side facing away from the driver reduce the kinetic energy of the upper body impact by allowing the gas to escape at a controlled rate.

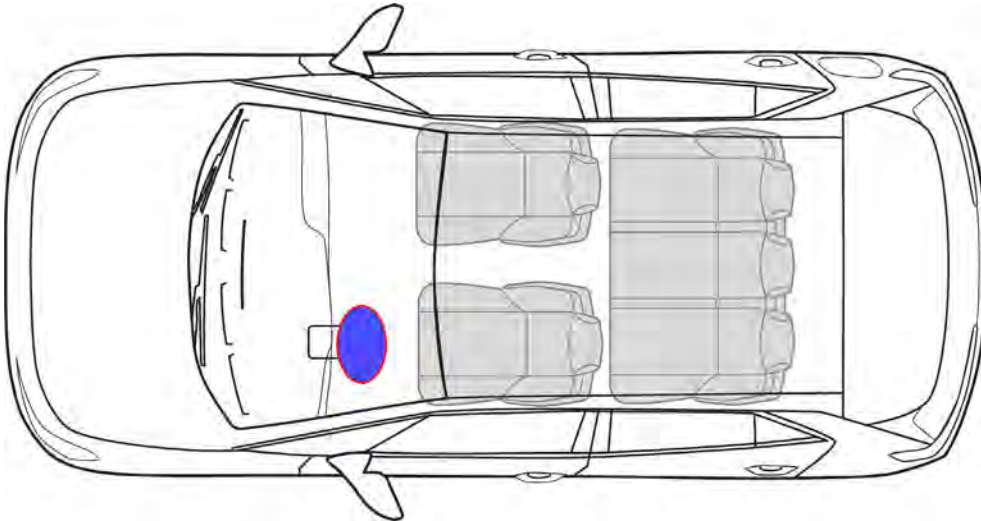

Front passenger airbag

The airbag unit for the front passenger is located in the dash panel in front of the passenger seat. Because the airbag unit is further from the occupant, the front passenger airbag has a much larger volume. The action, function and process sequence of the front passenger airbag are comparable to those of the driver airbag.

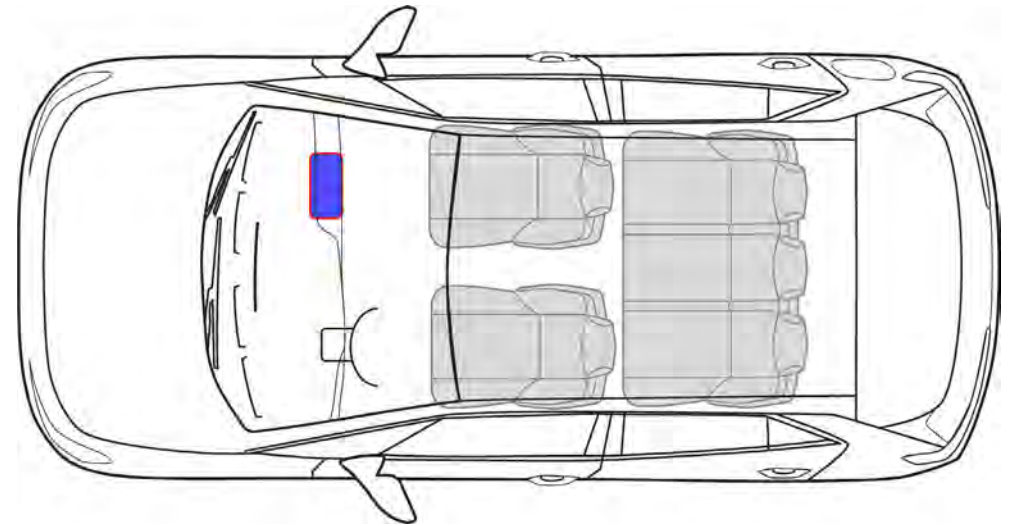

9. Important additional information

Knee airbag

The design of the knee airbag is similar to that of the front passenger airbag. It is located in the footwell trim below the dash panel.

The knee airbag is always deployed together with the driver airbag. Single-stage stored gas inflators are used to inflate the knee airbags.

The deployment of the knee airbag reduces the occupants' risk of knee and leg injury, and connects the occupant sooner to the vehicle's deceleration.

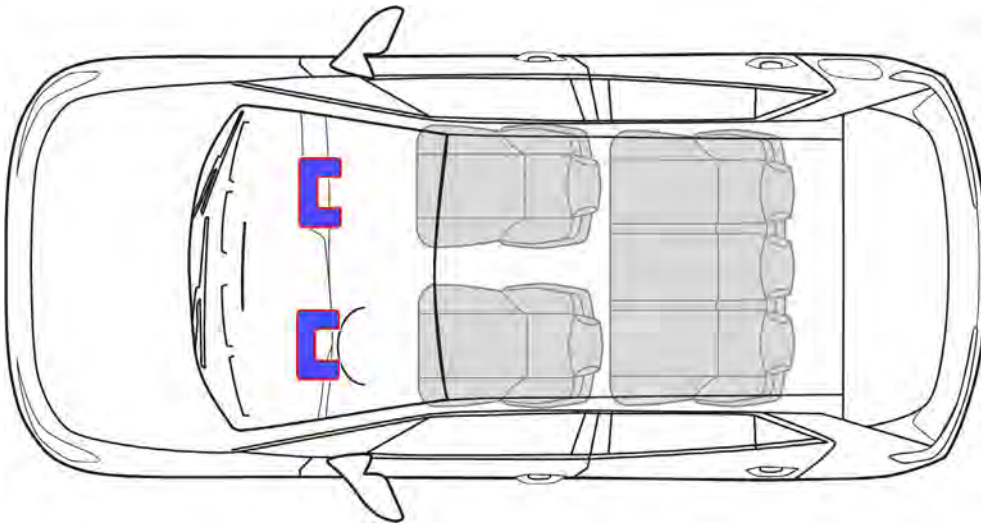

Side airbag

In a lateral collision, side airbags protect the occupant's thorax and pelvis on that side of the vehicle and reduce the impact on the occupant. They inflate at the side between the occupant's upper body and any trims that protrude, and therefore distribute the force of the impact on the occupant more evenly, who is thereby paired with the motion of the intrusion early on.

The side airbags are installed in the backrest of the driver and front passenger seats, and on the outer seats in the 2nd row of seats in a number of Volkswagen models. This guarantees a uniform distance to the vehicle occupants in every seat position.

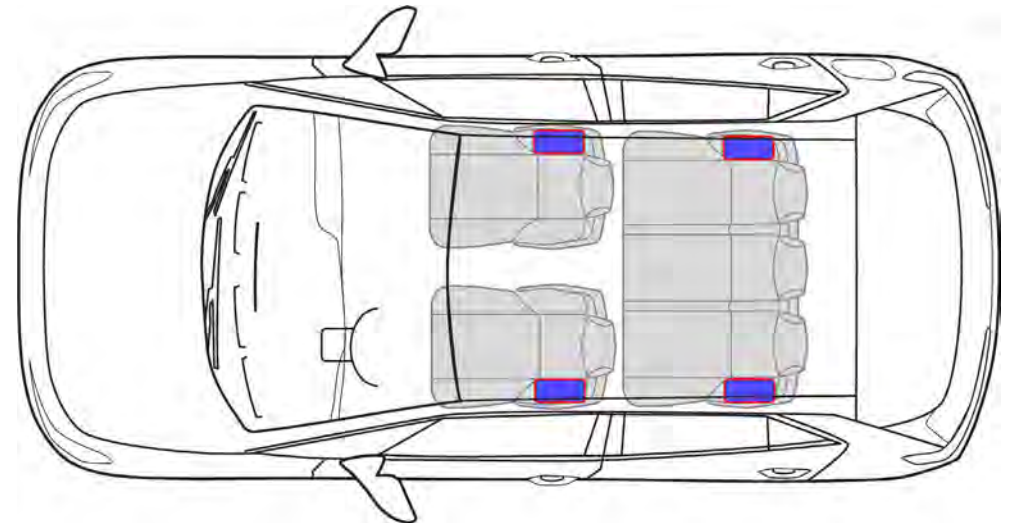

Head/thorax airbag

The head-thorax airbag for the driver and front passenger are integrated into the front seat backrests. The design and function are similar to those of a side airbag. It extends from the occupant's ribcage to the head and is particularly used in convertibles where a curtain airbag is not possible.

Centre airbag

Centre airbags are installed in the driver seat armrest on the tunnel side. They prevent a collision between the heads of the driver and the front passenger, and prevent the driver from being thrown too far to the passenger side if it is unoccupied.

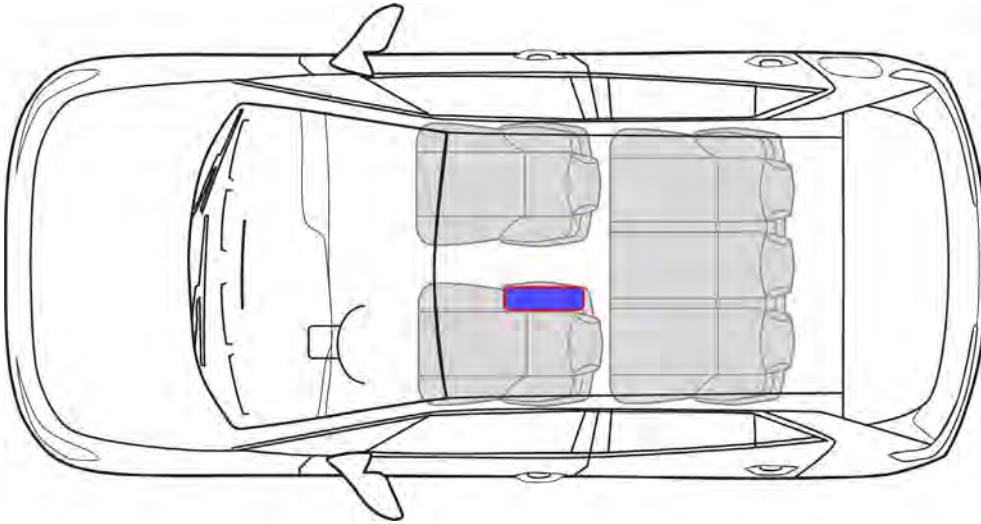

Curtain airbag

Curtain airbags protect the head in the event of a side impact. They consist of a large airbag up in the roof lining which usually extends from the A-pillar to the C-pillar.

Depending on the vehicle model, the stored gas inflators may be installed in the roof near the B-pillar, between the B- and C-pillars, between the C- and D-pillars or even in the rear roof area. The exact installation position is described on the rescue cards. In contrast to front and side airbags, the curtain airbag can retain its internal pressure for some time after being deployed. This is to provide protection if the vehicle subsequently overturns or secondary collisions occur.

Both the side and curtain airbags are deployed by the airbag control unit when a limit configured in it is reached. A side impact is detected by lateral acceleration sensors or pressure sensors in the doors.

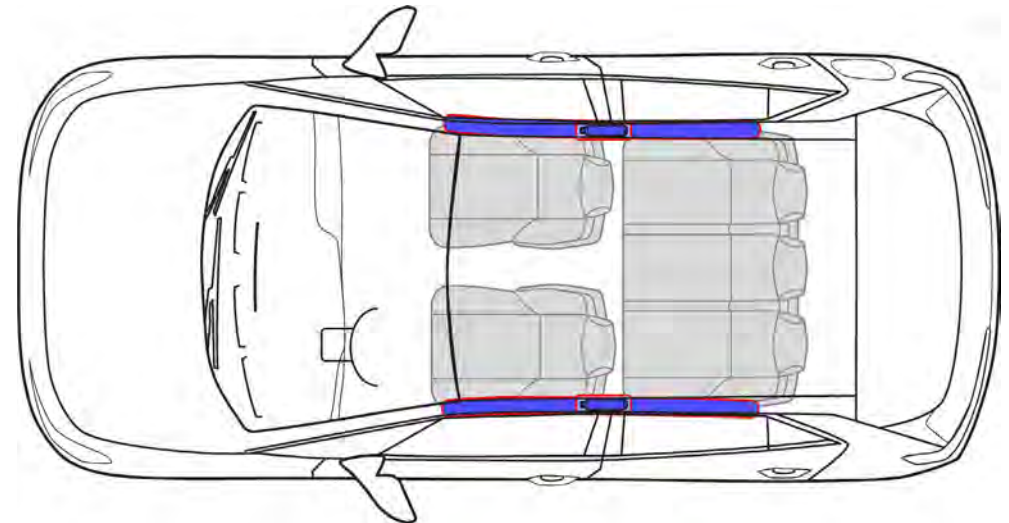

Airbag stored gas inflators

Solid propellant generators

The solid propellant stored gas inflators consist of a housing containing a solid propellant charge with an ignition unit. When the solid propellant is ignited, the airbag is filled with non-toxic gas.

Procedure:

- The igniter is activated by the airbag control unit.
- The propellant charge is ignited and quickly combusts.
- The gas thus produced flows through the metal filter into the airbag.

Hybrid stored gas inflators

The hybrid stored gas inflators consist of a housing containing a highly compressed gas, combined with a solid propellant charge and an ignition unit. The design and shape of the generator housing are adapted to the installation conditions. These generators are usually tubular. The main components are the pressure vessel for the airbag inflation gas, and the (solid) propellant charge which is integrated in the pressure vessel or flange-mounted on it. The solid propellant is used in tablet or ring form. The stored and compressed gas is a mixture of inert gases, for example argon and helium. Depending on the stored gas inflator design, it is pressurised to between 200 bar and 800 bar.





- When the solid propellant is ignited, it opens the pressure vessel, producing a gas mixture consisting of the solid propellant and the inert gas mixture. The igniter is activated by the airbag control unit and the propellant charge is ignited.



Do not damage the stored gas inflators during rescue work. The compressed gas in the pressure vessel and the pyrotechnic propellants may pose a hazard to the emergency services and the occupants.

Belt tensioners

In the event of a crash, belt tensioners retract the belt in the opposite direction to which it is being pulled – this reduces slack (a gap between the belt and the body). This acts as soon as possible to prevent the occupant from being thrown forward (relative to the motion of the vehicle). A belt tensioner can retract the seat belt by up to 200 mm within 10 milliseconds. The belt tensioners are integrated in the belt system. However, they may be installed in different locations depending on the type of vehicle (for example in the B-pillar, in the side member beside the seat or on the outside of the rear seat) and have different functional principles. In some cases, two belt tensioners may even be used on one seat.

	<p>This means belt tensioners should not be damaged with rescue equipment if at all possible. Avoid hammering on this area.</p>
	<p>The belt also locks if the vehicle is at a steep angle, has overturned, or possibly if the belt tensioner has been damaged by the accident.</p>
	<p>Non-triggered belt tensioners with mechanical activation can still be triggered even after the battery is disconnected.</p>
	<p>If the situation allows, the seat belt should be taken off or cut off as soon as possible.</p>
	<p>Identification of belt tensioners on the rescue card</p>

Belt tensioner installation variants

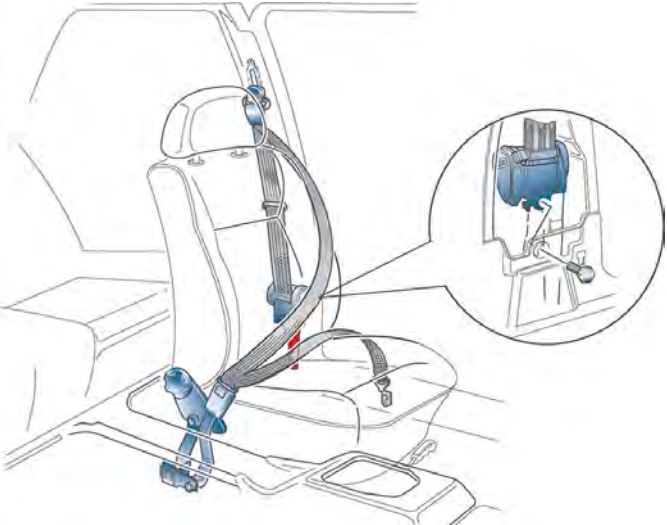
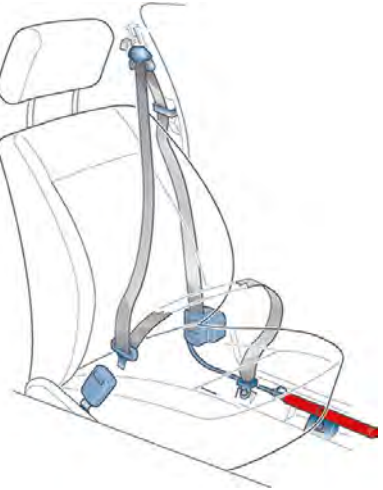
Variant	Fitting location
	<p>Variant 1 The front three-point automatic seat belt with the cylindrical belt tensioner and mechanical or electrical triggering of the ignition form a unit and are installed either:</p> <ul style="list-style-type: none"> a) In the B-pillar below the automatic belt retractors b) As external components next to the side member c) In the B-pillar above the automatic belt retractor <p>Installation variant 1a – Belt tensioner in the B-pillar below the belt retractor</p>
	<p>Installation variant 1b – Belt tensioner as external component next to the side member</p>

Belt tensioner installation variants

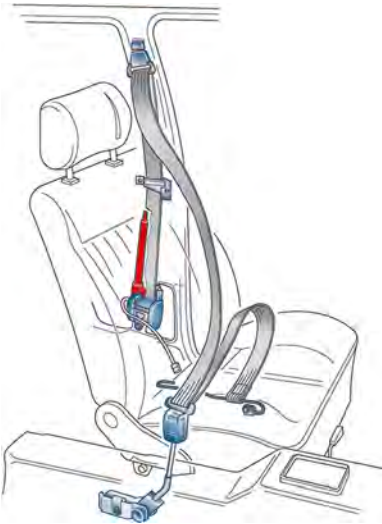
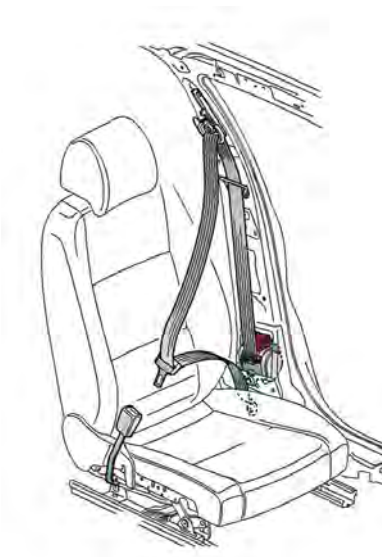
Variant	Fitting location
	<p>Installation variant 1c – Belt tensioner in the B-pillar above the belt retractor</p>
	<p>Variant 2 In the case of the front compact tensioner, the three-point automatic seat belt and belt tensioner with electric or mechanical ignition trigger form a single unit and are installed in the B-pillar.</p> <p>Installation variant 2 – Compact belt tensioner in the B-pillar</p>

Belt tensioner installation variants

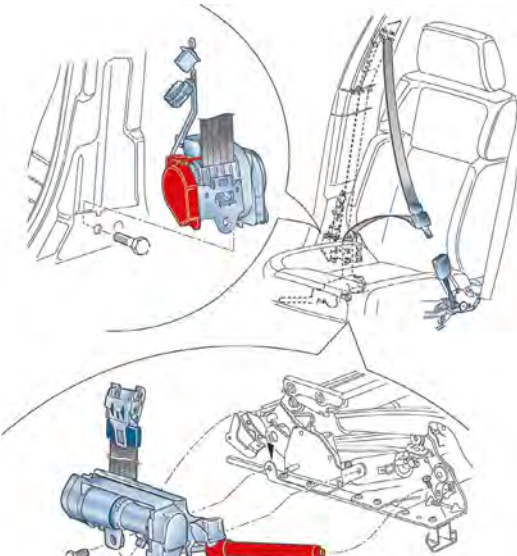
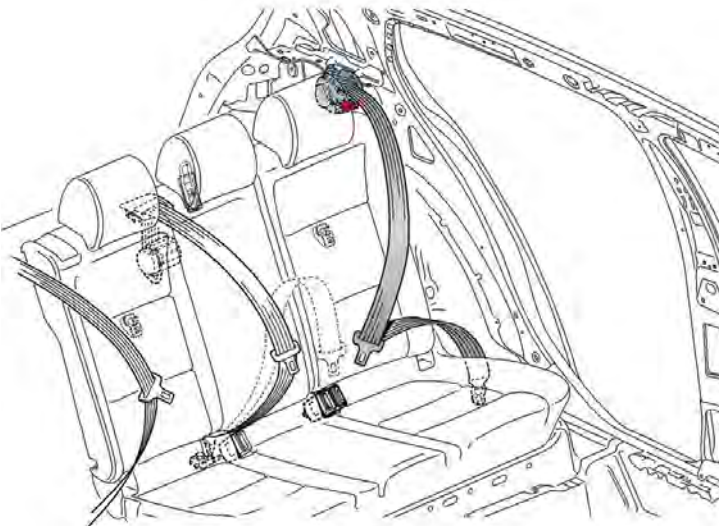
Variant	Fitting location
	<p>Variant 3 In the front twin tensioner, the shoulder section of belt with compact tensioner and the lap part of the seat belt with cylindrical tensioner form a functional unit.</p> <p>The electric ignition trigger of the shoulder section is located in the B-pillar and the trigger for the lap belt section is on the seat frame.</p> <p>Installation variant 3 – Twin belt tensioner in the B-pillar and seat frame</p>
	<p>Variant 4 In the rear compact tensioner, the three-point automatic seat belt and belt tensioner with electric or mechanical ignition trigger form a single unit and are installed behind the rear seat backrest.</p> <p>Installation variant 4 – Compact belt tensioner in the rear shelf</p>

Belt tensioner installation variants

Variant

Fitting location

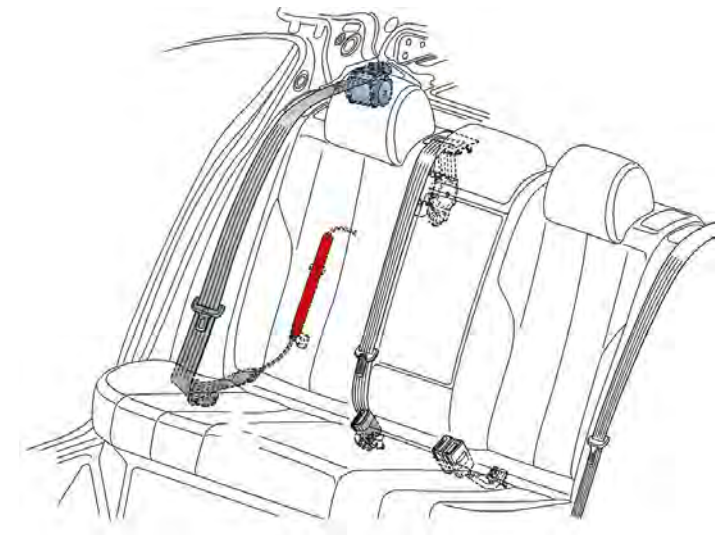

Variant 5

Three-point automatic seat belt and tensioner are arranged independently of each other. The belt tensioner with electric ignition trigger is installed in the wheel housing / C-pillar area.

Installation variant 5 – Rear belt pretensioner in the wheel housing / C-pillar area



Variant 6

Three-point seat belt and lap belt tensioner are installed separately. The lap belt tensioner with electric triggering of the ignition is installed at the side member/B-pillar.

Installation variant 6 – Lap belt tensioner in the side member / B-pillar area

Protective bar

Convertibles must provide the greatest possible protection for occupants even when the roof is open. This is why a rollover protection system is used, which in combination with reinforced A-pillars provides a protective zone for the occupants. It can be rigid or dynamic.



A dynamic system functions as follows:

- The airbag control unit contains a sensor for detecting if the vehicle is about to roll over.

Together with other sensors in the control unit, the severity of the accident is determined and the protective bar and belt tensioners are deployed.

The protective bar is also deployed as a precaution in the event of a severe frontal, lateral or rear impact as soon as a belt tensioner or airbag is triggered.

It is deployed via a protective bar trigger unit. A preloaded spring moves the bar to the protective position within 0.25 seconds, and it is locked in the extended position by a latching mechanism.

	<p>If the rear window is still intact when the protective bar is triggered, the protective bar will not break it. If the window is removed as part of the rescue operation, the protective bar is pushed up a further 10 cm. It could hit emergency and recovery personnel and scatter glass shards.</p>
	<p>Identification of protective bar on rescue card</p>

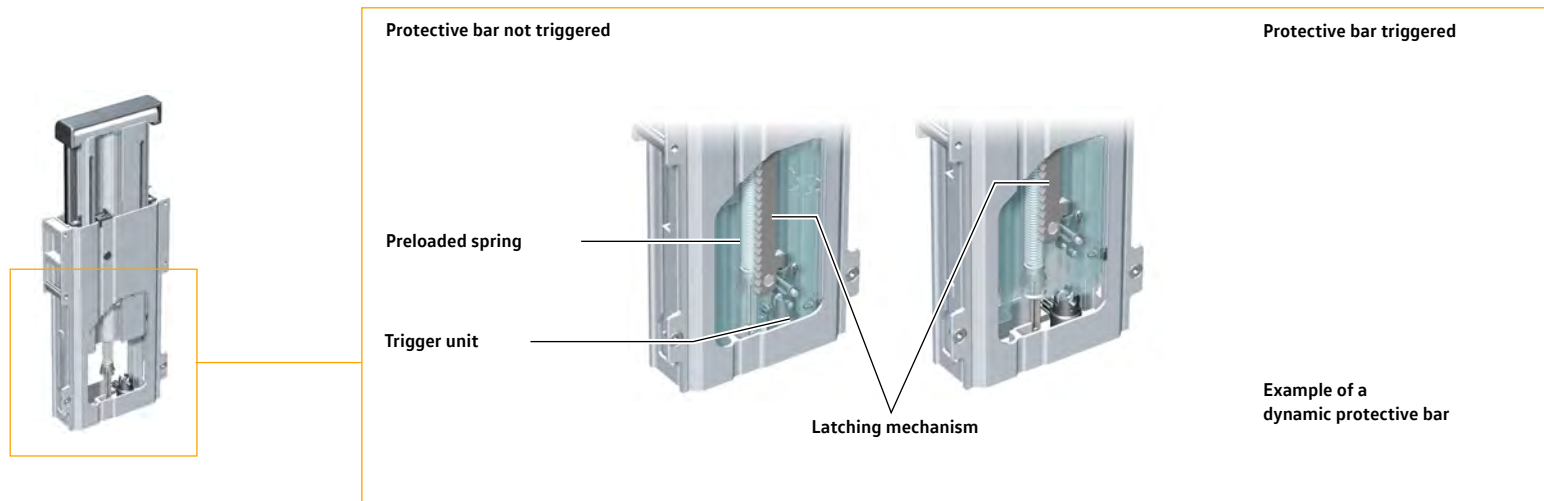

Re-active bonnet

To ensure optimum protection for pedestrians, some Volkswagen vehicles are equipped with a re-active bonnet.



In the event of a collision with a pedestrian, the front and rear of the active bonnet are raised by preloaded gas struts and pyrotechnic propellants.

This increases the space between the bonnet and engine. The bonnet can absorb more impact energy in this position, thereby reducing the severity of injury caused by the engine.

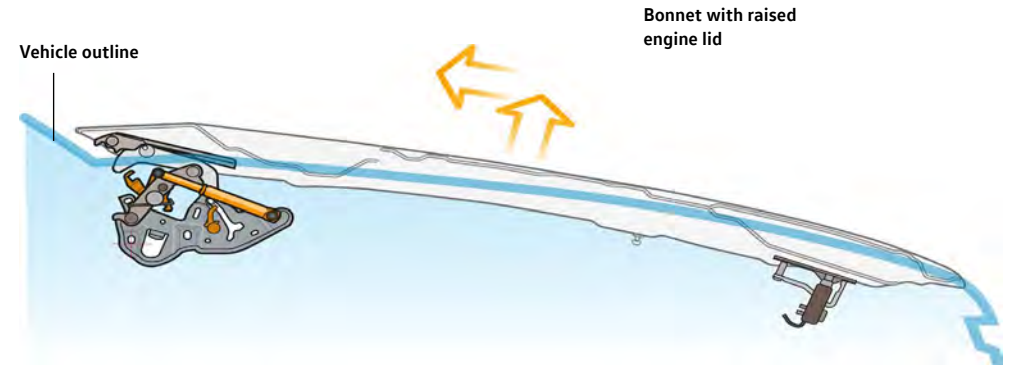

Example of a re-active bonnet with pyrotechnic actuator.



	<p>Do not damage the stored gas inflators during rescue work. The compressed gas in the pressure vessel and the pyrotechnic propellants may pose a hazard to the emergency services and the occupants.</p>
	<p>Identification of re-active bonnet on rescue card</p>

Sources, further information

- VDA: Accident assistance and recovery of vehicles with 48 V and high-voltage systems
- DGUV: Hinweise für die Brandbekämpfung von Lithium-Ionen-Akkus bei Fahrzeugbränden (Information for fighting fires in lithium-ion batteries in vehicle fires) (FBFHB 024)

10. Explanation of pictograms used

10. Explanation of pictograms used

Components, functions and measures that have to be taken into account during a rescue operation are indicated by special pictograms.

The pictograms are used:

- To indicate, together with the rescue card illustration, where the respective components/functions are located in the vehicle (for details, see ISO 17840-1 and ISO 17840-2)
- To indicate a specific function or danger; they can be used in the sections of the additional pages of the rescue card or the guide for emergency personnel
- To show how to identify the type of drive
- To indicate fire extinguishing measures.

Importance:

1 = Information that is essential for the rescue depending on the vehicle type/model

2 = Optional information which provides additional support for rescue measures

The following tables list the pictograms used by Volkswagen for passenger cars and light commercial vehicles and the components and functions to be taken into account.

Pictograms concerning recognition



Examples for identifying the drive type

Reference: ISO 17840-4

Importance: 1

Used for:

- Rescue card illustration
- Guide for emergency personnel, section 1

Note: Example pictograms for petrol and electric drive systems are shown here.

See ISO 17840-4 for principles and other drive pictograms.



A number of pictograms may be adapted to reflect the actual size and shape.

A combination of simple forms can also be used.

10. Explanation of pictograms used

Pictograms concerning access to the components



Title/meaning/reference:
Bonnet

Function/description:
Identifies the control that opens the compartment outside the interior at the front of the vehicle. The pictogram may have a frame to distinguish it from the background.

Importance: 2

Used for:

- Rescue card illustration
- Guide for emergency personnel, section 3

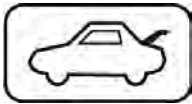

Boot

Identifies the control that opens the compartment outside the interior on the rear of the vehicle. The pictogram may have a frame to distinguish it from the background.

Importance: 2

Used for:

- Rescue card illustration
- Additional pages of the rescue card, section 3
- Guide for emergency personnel, section 3

Pictograms concerning disabling of the vehicle (excluding high voltage)



Device to shut down power in the vehicle

All power sources in the vehicle are switched off using:

- Ignition key
- Button
- Measure in the engine compartment
- Measure on the dash panel
- Battery switch
- Other measure

Importance: 1

Used for:

- Rescue card illustration
- Additional pages of the rescue card, section 3
- Guide for emergency personnel, section 3



Remove smart key

Reminder to remove the Keyless Access key from the vehicle so that the engine is not accidentally started. Optionally, a safety distance may be specified.

Importance: 1

Used for:

- Rescue card illustration
- Additional pages of the rescue card, section 3
- Guide for emergency personnel, section 3

10. Explanation of pictograms used

Pictograms concerning disabling of the vehicle (excluding high voltage)

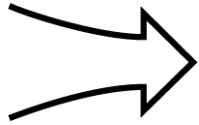

Air intake

Identifies the air intake that can admit CO₂ to stop the engine.

Importance: 1

Used for:

- Rescue card illustration
- Additional pages of the rescue card, section 3
- Guide for emergency personnel, section 3

Pictograms concerning disabling of the vehicle high voltage (EV, HEV, PHEV, FCEV)



Vehicle induction charging

Indicates that the vehicle is connected to an electromagnetic induction source for charging the high-voltage batteries. Shows the location of the induction charging system and its components.

Importance: 1

Used for:

- Rescue card illustration
- Additional pages of the rescue card, section 3
- Guide for emergency personnel, section 3

Pictograms concerning disabling of the vehicle high voltage (EV, HEV, PHEV, FCEV)

- Orange = high-voltage system (class B voltage)
- Yellow = control of the high-voltage system by the low-voltage system
- Orange coloured frame = procedure for disabling the high-voltage vehicle



Dangerous voltage

Indicates hazards caused by dangerous voltages.

Importance: 1

Used for:

- Rescue card illustration
- Additional pages of the rescue card, relevant section as necessary
- Guide for emergency personnel, relevant section as necessary

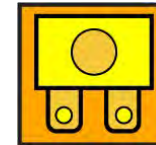

Fuse box disabling high voltage

Identifies the low-voltage fuse that controls the high-voltage system.

Importance: 1

Used for:

- Illustration and additional pages of the rescue card, section 3
- Guide for emergency personnel, section 3



Cable cut

Identifies which cable to cut in order to disconnect the high-voltage and SRS components from the power network. Indicates that the cable must be cut at two separate points. The size and proportions may be adapted to the intended purpose.

Importance: 1

Used for:

- Illustration and additional pages of the rescue card, section 3
- Guide for emergency personnel, section 3



10. Explanation of pictograms used

Pictograms concerning disabling of the vehicle high voltage (EV, HEV, PHEV, FCEV)



High voltage device that disconnects high voltage (e.g. maintenance connector)

Identifies the device that disconnects the high-voltage system, as well as the personal protective equipment (PPE) that may have to be used.

Importance: 1

Used for:

- Rescue card illustration
- Illustration and additional pages of the rescue card, section 3
- Guide for emergency personnel, section 3



Low voltage device that disconnects high voltage

Identifies the low-voltage device that disconnects the high-voltage system.

Importance: 1

Used for:

- Rescue card illustration
- Illustration and additional pages of the rescue card, section 3
- Guide for emergency personnel, section 3

Pictograms concerning access to occupants

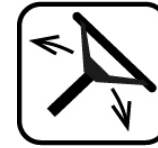

Steering wheel, tilt control

Identifies the control for adjusting the steering wheel inclination up or down. The pictogram may have a frame to distinguish it from the background.

Importance: 2

Used for:

- Guide for emergency personnel, section 4



Seat height adjustment

Identifies the control for adjusting the seat height up or down. The pictogram may have a frame to distinguish it from the background.

Importance: 2

Used for:

- Guide for emergency personnel, section 4



Seat adjustment, longitudinal

Identifies the control for moving the seat forward or back. The pictogram may have a frame to distinguish it from the background.

Importance: 2

Used for:

- Guide for emergency personnel, section 4

10. Explanation of pictograms used

Pictograms concerning access to occupants



Lifting point; central support

Identifies the points on the vehicle that the manufacturer deems suitable for placing a jack or support.

Importance: 1

Used for:

- Rescue card illustration
- Illustration and additional pages of the rescue card, section 2
- Guide for emergency personnel, section 2

Other vehicle related pictograms



Airbag

Identifies an airbag.

Airbag versions, e.g.:

- Driver/front passenger airbags
- Side airbag
- Curtain airbag
- Knee airbag
- Belt airbag
- Centre airbag

Importance: 1

Used for:

- Rescue card illustration
- Guide for emergency personnel, section 9

Other vehicle related pictograms



Airbag stored gas inflator

Identifies an airbag stored gas inflator.

The pictogram shows the location of a stored gas inflator, e.g. for curtain airbags or active pedestrian protection systems.

This pictogram is not used for conventional airbag systems with integrated stored gas inflators, such as the front airbag in the steering wheel or dash panel, side airbags and knee airbag.

Importance: 1

Used for:

- Rescue card illustration
- Guide for emergency personnel, section 9



Seat belt pretensioner

Identifies a belt tensioner.

If a seat has more than one belt tensioner (e.g. for hip and shoulder belts), all belt tensioner positions should be indicated with a pictogram.

Importance: 1

Used for:

- Rescue card illustration
- Guide for emergency personnel, section 9

10. Explanation of pictograms used

Other vehicle related pictograms



Gas strut / Preloaded spring

Identifies a gas strut.

The red border is only used when the device is triggered.
The pictogram can be modified to reflect the actual size and shape.

Importance: 1

Used for:

- Rescue card illustration
- Guide for emergency personnel, section 9



Pedestrian protection active system

Identifies the active pedestrian protection system.

The pictogram for active pedestrian protection systems is intended to indicate that the vehicle is equipped with a system that can be triggered (e.g. the bonnet).
The background of the pictogram is usually white, but the colour of the trigger mechanism may be used as an alternative.

The pictogram can be combined with the trigger mechanism of the system (e.g. bonnet) or connected to it (airbag, stored gas inflator, gas strut, preloaded spring).

Importance: 1

Used for:

- Rescue card illustration
- Guide for emergency personnel, section 9



High strength zone

Identifies a high-strength area.

Importance: 1

Used for:

- Rescue card illustration
- Guide for emergency personnel, section 9

Other vehicle related pictograms

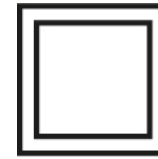

Zone requiring special attention

Identifies the area to which particular attention should be paid.

Importance: 1

Used for:

- Illustration and additional pages of the rescue card, section 5
- Guide for emergency personnel, section 5



Carbon structure

Information that the vehicle body contains carbon. Indicates that there is a risk of inhalation and that appropriate PPE must be used.

Importance: 1

Used for:

- Illustration and additional pages of the rescue card, section 5
- Guide for emergency personnel, section 5



Left hand drive

Identifies a left-hand drive vehicle.

For use in the header of the rescue card.

The colour may be changed to stand out from the background of the header.

Importance: 1

Used for:

- Rescue card illustration

10. Explanation of pictograms used

Other vehicle related pictograms



Right hand drive

Identifies a right-hand drive vehicle.

For use in the header of the rescue card.
The colour may be changed to stand out from the background of the header.

Importance: 1

Used for:
– Rescue card illustration

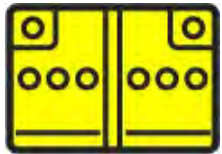

Battery, low voltage

Identifies a low-voltage battery.

The battery technology should also be indicated (e.g. Li-Ion or NiMH) if it is not a conventional battery.

Importance: 1

Used for:
– Rescue card illustration
– Illustration and additional pages of the rescue card, section 5
– Guide for emergency personnel, section 5



Ultra-capacitor, low-voltage

Identifies a low-voltage supercapacitor.

Importance: 1

Used for:
– Rescue card illustration
– Illustration and additional pages of the rescue card, section 5
– Guide for emergency personnel, section 5

Other vehicle related pictograms

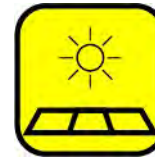

Solar Panel

Identifies a solar cell.

Importance: 1

Used for:
– Rescue card illustration
– Illustration and additional pages of the rescue card
– Guide for emergency personnel, section 3



SRS control unit

Identifies an SRS control unit.

Importance: 1

Used for:
– Rescue card illustration
– Guide for emergency personnel, section 9

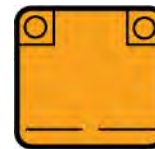

Battery pack, high-voltage

Identifies a high-voltage battery.

The battery technology should also be indicated (e.g. Li-Ion or NiMH). Optionally, the nominal voltage of the battery can be indicated.

Importance: 1

Used for:
– Rescue card illustration
– Additional pages of the rescue card, section 3
– Guide for emergency personnel, section 3

10. Explanation of pictograms used

Other vehicle related pictograms



High voltage ultra-capacitor

Identifies a high-voltage supercapacitor.

Importance: 1

Used for:

- Rescue card illustration
- Illustration and additional pages of the rescue card, section 5
- Guide for emergency personnel, section 5



High voltage component

Identifies a high-voltage component.

The lightning bolt may be omitted if there is not enough space.

Importance: 1

Used for:

- Rescue card illustration
- Illustration and additional pages of the rescue card
- Guide for emergency personnel, section 3



High voltage power cable

Identifies a high-voltage cable.

It should be possible to distinguish high-voltage components from the high-voltage battery. The key and the pictogram graphics should match each other with regard to the line concept used for the frames.

Importance: 1

Used for:

- Rescue card illustration
- Illustration and additional pages of the rescue card

Other vehicle related pictograms



Fuel tank content Diesel

Indicates the tank capacity with a defined colour.

Importance: 1

Used for:

- Rescue card illustration
- Additional pages of the rescue card, section 5
- Guide for emergency personnel, section 5



Fuel tank content gasoline/ethanol

Indicates the tank capacity with a defined colour.

Importance: 1

Used for:

- Rescue card illustration
- Additional pages of the rescue card, section 5
- Guide for emergency personnel, section 5



Gas tank with gas type indication (CNG)

Indicates the tank capacity with a defined colour and names the type of gas.

Importance: 1

Used for:

- Rescue card illustration
- Additional pages of the rescue card, section 3
- Guide for emergency personnel, section 3

10. Explanation of pictograms used

Other vehicle related pictograms



Manual gas shut-off valve with gas type indication (CNG)

Indicates the manual gas shut-off valve with a defined colour and names the type of gas.

Importance: 1

Used for:

- Rescue card illustration
- Additional pages of the rescue card, section 3
- Guide for emergency personnel, section 3



Automatic gas overpressure safety valve with gas type indication (CNG)

Indicates the device that controls gas overpressure in a tank with a defined colour and names the type of gas.

- Pressure-controlled (pressure relief device)
- Temperature-controlled (temperature-controlled pressure relief device)

Importance: 1

Used for:

- Rescue card illustration
- Additional pages of the rescue card, section 3
- Guide for emergency personnel, section 5



Gas tank with gas type indication (LPG)

Indicates the tank capacity with a defined colour and names the type of gas.

Importance: 1

Used for:

- Rescue card illustration
- Additional pages of the rescue card, section 3
- Guide for emergency personnel, section 3

Other vehicle related pictograms



Manual gas shut-off valve with gas type indication (LPG)

Indicates the manual gas shut-off valve with a defined colour and names the type of gas.

Importance: 1

Used for:

- Rescue card illustration
- Additional pages of the rescue card, section 3
- Guide for emergency personnel, section 3



Automatic gas overpressure safety valve with gas type indication (LPG)

Indicates the device that controls gas overpressure in a tank with a defined colour and names the type of gas.

- Pressure-controlled (pressure relief device)
- Temperature-controlled (temperature-controlled pressure relief device)

Importance: 1

Used for:

- Rescue card illustration
- Additional pages of the rescue card, section 3
- Guide for emergency personnel, section 5



Gas pipe (general)

Identifies a gas line with a defined colour.

Importance: 1

Used for:

- Rescue card illustration
- Guide for emergency personnel, section 5

10. Explanation of pictograms used

Other vehicle related pictograms



Direction of gas overpressure safety valve (e.g. LPG) in vehicle

Indicates the direction of the gas safety valve in an illustration with a defined colour.

Importance: 1

Used for:

- Rescue card illustration



Compressed air tank

Identifies a compressed air tank.

Importance: 1

Used for:

- Rescue card illustration
- Guide for emergency personnel, section 5



Air-conditioning component

Identifies an air-conditioning component with a defined colour.

The coolant must be specified on the additional pages and the rescue card (e.g. CO₂ fluorocarbon basis).
If there is not enough space, the snowflake may be omitted.

Importance: 1

Used for:

- Rescue card illustration
- Additional pages of the rescue card, section 5
- Guide for emergency personnel, section 5

Other vehicle related pictograms



Air-conditioning line

Identifies a gas line with a defined colour.

The type or designation of the coolant must be identified (e.g. CO fluorocarbon basis).

Importance: 1

Used for:

- Rescue card illustration
- Guide for emergency personnel, section 5

Pictograms related to fire fighting and safety



General warning sign

Indicates a general warning.

Importance: 1

Used for:

- Additional pages of the rescue card, corresponding sections as necessary
- Guide for emergency personnel, corresponding sections as necessary



Warning: Electricity

Warns of electricity and dangerous voltage.

Importance: 1

Used for:

- Additional pages of the rescue card, corresponding sections as necessary
- Guide for emergency services

10. Explanation of pictograms used

Pictograms related to fire fighting and safety



Warning: low temperature

Indicates hazards caused by low temperatures, e.g. frostbite from cold gases (e.g. LNG, air conditioning gas).

Importance: 1

Used for:

- Additional pages of the rescue card, sections 5, 6 and 8
- Guide for emergency personnel, sections 5, 6, 8 and 9



Use thermal infrared camera

Indicates that a thermal infrared camera should be used to detect a fire.

Importance: 2

Used for:

- Additional pages of the rescue card, section 6
- Guide for emergency personnel, section 6



Automatic fire suppression system

Indicates that the vehicle has an automatic fire extinguisher system.

Importance: 1

Used for:

- Rescue card illustration
- Additional pages of the rescue card, section 6
- Guide for emergency personnel, section 6

Pictograms related to fire fighting and safety



Special battery access

Special access through which water can be poured into the high-voltage battery of an electric vehicle.

Importance: 1

Used for:

- Additional pages of the rescue card, section 6
- Guide for emergency personnel, section 6



Use water to extinguish the fire

Indicates that a fire must be extinguished with water.

Importance: 1

Used for:

- Additional pages of the rescue card, section 6
- Guide for emergency personnel, section 6



Use wet foam (DLS) to extinguish the fire

Indicates that a fire must be extinguished with wet compressed air foam. System in which foam and air are constantly mixed under pressure with the water from the fire extinguishing centrifugal pump (CAFS).
When using wet compressed air foam, the nominal ratio of foam to air volume is 1:3 to 1:10 for mixture in the CAFS.

Importance: 1

Used for:

- Additional pages of the rescue card, section 6
- Guide for emergency personnel, section 6

10. Explanation of pictograms used

Pictograms related to fire fighting and safety



Use dry foam (DLS) to extinguish the fire

Indicates that a fire must be extinguished with dry compressed air foam. System in which foam and air are constantly mixed under pressure with the water from the fire extinguishing centrifugal pump (CAFS). When using dry compressed air foam, the nominal ratio of foam to air volume is more than 1:10 for mixture in the CAFS.

Importance: 1

Used for:

- Additional pages of the rescue card, section 6
- Guide for emergency personnel, section 6



Use ABC powder to extinguish the fire

Indicates that a fire must be extinguished with ABC powder.

Importance: 1

Used for:

- Additional pages of the rescue card, section 6
- Guide for emergency personnel, section 6



Do not extinguish with water

Prohibits the use of water to extinguish a fire.

Importance: 1

Used for:

- Additional pages of the rescue card, section 6
- Guide for emergency personnel, section 6

Worldwide standard symbols



Explosive

Indicates the risk of explosion.

Importance: 1

Used for:

- Additional pages of the rescue card, sections 5, 6, 8 and 9
- Guide for emergency personnel, sections 5, 6, 8 and 9



Flammable

Indicates danger due to flammability.

Importance: 1

Used for:

- Additional pages of the rescue card, sections 5, 6, 8 and 9
- Guide for emergency personnel, sections 5, 6, 8 and 9



Gases under pressure

Indicates danger due to pressurised gases.

Importance: 1

Used for:

- Additional pages of the rescue card, sections 5, 6, 8 and 9
- Guide for emergency personnel, sections 5, 6, 8 and 9

10. Explanation of pictograms used

Worldwide standard symbols



Oxidiser

Indicates danger due to substances that intensify fire.

Importance: 1

Used for:

- Additional pages of the rescue card, sections 5, 6, 8 and 9
- Guide for emergency personnel, sections 5, 6, 8 and 9



Corrosives

Indicates danger due to corrosive substances.

Importance: 1

Used for:

- Additional pages of the rescue card, sections 5, 6, 8 and 9
- Guide for emergency personnel, sections 5, 6, 8 and 9



Hazardous to the human health

Indicates a hazard to human health.

Importance: 1

Used for:

- Additional pages of the rescue card, sections 5, 6, 8 and 9
- Guide for emergency personnel, sections 5, 6, 8 and 9



Acute toxicity

Indicates danger due to acute toxicity.

Importance: 1

Used for:

- Additional pages of the rescue card, sections 5, 6, 8 and 9
- Guide for emergency personnel, sections 5, 6, 8 and 9

Worldwide standard symbols



Environmental hazard

Indicates the risk of endangering the environment.

Importance: 1

Used for:

- Additional pages of the rescue card, sections 5, 6, 8 and 9
- Guide for emergency personnel, sections 5, 6, 8 and 9

Symbols used in this guide



Warning: potentially explosive materials

ISO 7010



Note

General information